

www.versa-lok.com

VERSA-LOK[®]
Retaining Wall Systems
Solid Solutions[™]



Standard

Design & Installation Guidelines

Welcome

*Welcome to
the VERSA-LOK
Standard
Retaining Wall
System Design
and Installation
Guidelines.*

This guide is intended to illustrate design and construction capabilities of the VERSA-LOK® Standard Retaining Wall System. There are many variables to consider, however, when planning or constructing any segmental retaining wall. Soil types, drainage, loading, topography and height need to be addressed on every project to ensure safe, trouble-free installation.

Walls which support heavy loads or exceed 4 feet in height require special soil reinforcement and often professionally designed plans.

Consult a qualified engineer if you are unsure about any construction, site or soil conditions.

VERSA-LOK offers a variety of technical support, including in-house engineering assistance and reference literature. Please call 800-770-4525 with questions or to request the following: You also can download Technical Bulletins, product specifications and details from the VERSA-LOK website at www.versa-lok.com.

- **Technical Bulletin #1**
Shoreline, Waterway and Retention Pond Protection
- **Technical Bulletin #2**
Stairs
- **Technical Bulletin #3**
Curves and Corners
- **Technical Bulletin #4**
Caps
- **Technical Bulletin #5**
Base Installation
- **Technical Bulletin #6**
Freestanding Walls, Columns and Vertical Walls
- **Technical Bulletin #7**
Tiered Walls
- **Technical Bulletin #8**
Fences, Railings and Traffic Barriers

Also available from VERSA-LOK:

- **Design and Installation Guidelines**
- VERSA-LOK Mosaic®
- **Technical Documentation for Versa-Grid® Soil Reinforcement**
- **VERSA-LOK Standard and Mosaic Construction Details CD-Rom containing specifications and drawings created with AutoCAD® software**

AutoCad is a registered trademark of Autodesk, Inc.

Table of Contents

1 Introduction & Unit Specifications	3
2 System Overview	5
3 Wall Components	6
• <i>Typical Section</i>	
• <i>Foundation</i>	
• <i>Embedment</i>	
• <i>Soils and Compaction</i>	
• <i>Drainage Within Walls</i>	
• <i>Surface Drainage</i>	
• <i>Geosynthetic Reinforcement</i>	
4 Engineering	11
5 Special Design Considerations	13
• <i>Shorelines</i>	
• <i>Loads Behind Walls</i>	
• <i>Slopes</i>	
• <i>Tiering</i>	
6 Planning, Estimating & Final Designs	15
7 Wall Construction	16
• <i>Tools</i>	
• <i>Unit Modification</i>	
• <i>Excavation</i>	
• <i>Leveling Pad</i>	
• <i>Base Course</i>	
• <i>Additional Courses</i>	
• <i>Drainage Materials</i>	
• <i>Compacted Soil Backfill</i>	
• <i>Geosynthetic Soil Reinforcement</i>	
• <i>Caps</i>	
.....	25
8 Basic Wall Design Elements	
• <i>Curves</i>	
• <i>Corners</i>	
• <i>Stepped Base</i>	
• <i>Stepped Wall Top</i>	
• <i>Returns</i>	
.....	29
9 Advanced Wall Features	
• <i>Stairs</i>	
• <i>Freestanding Walls</i>	
• <i>Columns</i>	
• <i>Guardrails, Railings and Traffic Barriers</i>	
SUPPLEMENTAL INFORMATION	
Material Estimation Worksheet	31
VERSA-Grid® Estimation Charts	32
VERSA-LOK Standard Specifications	33-39
VERSA-LOK Standard Construction Detail Drawings	40-46

This guide demonstrates the exceptional design capabilities and easy installation methods of the VERSA-LOK Standard Retaining Wall System.

Introduction & Unit Specifications

VERSA-LOK® Standard units can be used to build walls in excess of 50 ft. when using appropriate geosynthetic reinforcement and proper design.

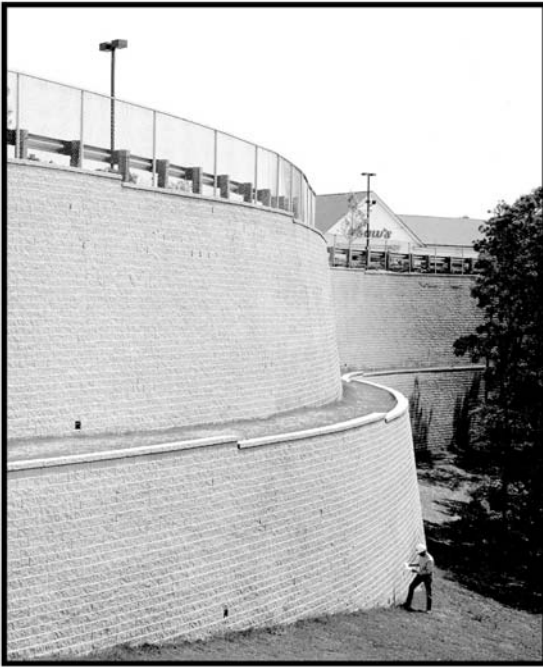

The VERSA-LOK Standard Retaining Wall System is a permanent, attractive, preferred alternative to ordinary retaining wall types. Standard walls display a natural split-face texture to complement any environment and, because they are made of concrete, are environmentally safe.

VERSA-LOK Standard retaining walls are economically installed without mortar and do not require concrete footings. In addition, one Standard unit is used to build straight walls, inside corners, outside corners, curves and stairs. No special units need to be ordered or estimated. Matching concrete caps are available to attractively finish any VERSA-LOK Standard wall.

The VERSA-LOK Standard System has earned widespread approval from architects, engineers and contractors. It provides unlimited design flexibility, unsurpassed durability and fast installation. The VERSA-LOK Standard system may be easily installed by contractors, grounds maintenance personnel or municipal construction crews.

VERSA-LOK Standard retaining wall units are ideal for residential, commercial and agency projects. They are routinely used by many state transportation departments and the U.S. Army Corps of Engineers. Properly designed, Standard walls may be constructed to heights in excess of 50 feet.

VERSA-LOK Standard solid retaining wall units are made from high-strength, low-absorption concrete on standard block machines. Solid characteristics make Standard units resistant to damage before, during and after construction in all climates.

Holes and slots molded into units accept VERSA-TUFF® Pins, which are non-corrosive, glass-reinforced nylon pins. Pins interlock units and help provide consistent alignment. This unique hole-to-slot pinning system permits easy variable-bond construction—keeping vertical joints tight.

Introduction & Unit Specifications

VERSA-LOK STANDARD UNITS

(Actual unit size and weight may vary slightly by region.)

Standard units are made from high-strength, low-absorption concrete on concrete block machines. The Standard units' solid characteristics make them resistant to damage before, during and after construction in all climates, including shoreline applications.

Height:	6 inches	152.4 mm
Width (face):	16 inches	406.4 mm
Width (rear):	14 inches	355.6 mm
Depth:	12 inches	304.8 mm
Face Area:	2/3 ft ²	0.062 m ²
Volume:	.63 ft ³	0.018 m ³
Weight:	82 lbs.	37.19 kg
Wgt/Face Area:	123 lbs./ft ²	599.84 kg/m ²

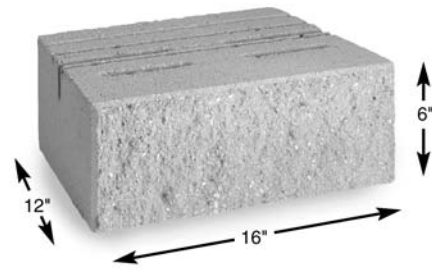

Solid VERSA-LOK Standard units provide superior durability and construction stability.

VERSA-TUFF® PIN

Length:	6.8 inches	172.7 mm
Diameter:	.48 inches	12.2 mm
Material:	Glass-Reinforced Nylon	



VERSA-LOK CAP UNITS

Height:	3-5/8 inches	92.1 mm
Width (face):	14 inches	355.6 mm
Width (rear): A Cap	12 inches	304.8 mm
B Cap	16 inches	406.4 mm
Depth:	12 inches	304.8 mm
Weight: A Cap	40 lbs.	18.14 kg
B Cap	50 lbs.	22.68 kg

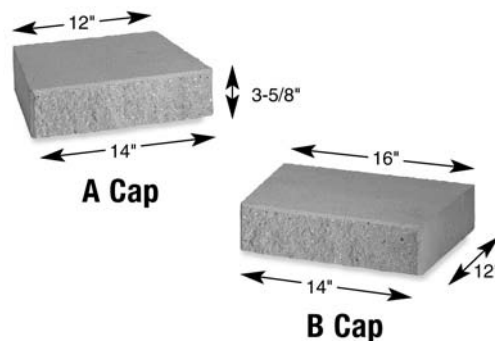

VERSA-LOK® Standard System Overview

Pinning

VERSA-LOK Standard units interlock with non-corrosive VERSA-TUFF® Pins (two per unit). As wall courses are installed, pins are inserted through holes in uppermost course units and are received in slots of adjacent lower course units. Pinning helps to align units in a consistent 3/4-inch setback per course.

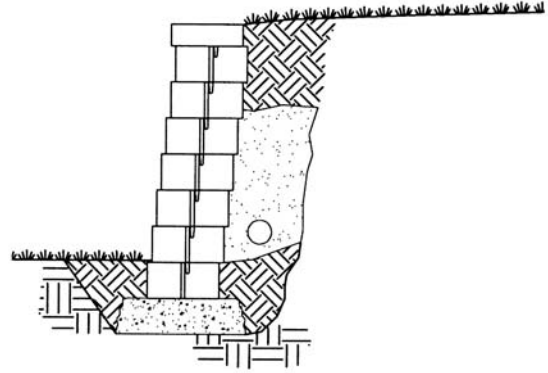
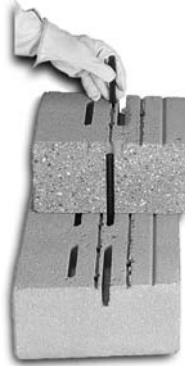

VERSA-LOK Standard units have a unique hole-to-slot pinning system for easy installation and superior structural integrity.

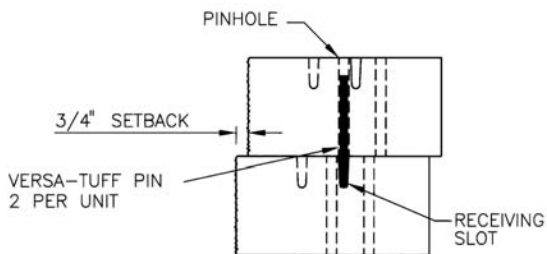

Pinning Detail

Unreinforced Walls

On many projects, VERSA-LOK Standard retaining walls work purely as gravity systems; unit weight alone provides resistance to earth pressures. Frictional forces between units and pin connections hold units together so walls behave as coherent structures. Batter setback of wall faces offers additional resistance against overturning.

Maximum allowable wall height for gravity walls varies with soil and loading conditions. Generally, with level backfill, good soils and no excessive loading, VERSA-LOK Standard gravity walls are stable to heights of 4 feet.

Reinforced Walls

When weight of units alone is not enough to resist soil loads, horizontal layers of geosynthetics are used to reinforce soil behind walls. With proper soil reinforcement and design, VERSA-LOK Standard walls can be constructed to heights in excess of 50 feet. Geosynthetics do not act as tie-backs for wall faces. Rather, geosynthetics and soil combine to create reinforced soil structures that are strong and massive enough to resist forces exerted on them. In soil-reinforced walls, Standard units simply retain soil between layers of geosynthetics and provide attractive, durable faces.

Refer to next page

VERSA-LOK® Standard Wall Components

Reinforced Wall Typical Section

This cross section illustrates typical components of VERSA-LOK Standard retaining walls. Mortarless Standard walls are installed on granular leveling pads and do not require concrete footings below frost. The amount and layout of drainage materials and geosynthetic soil reinforcement is site/soil dependent and should be designed by a qualified engineer. The 3/4-inch setback of each unit creates a cant of approximately 7 degrees. Canted walls are structurally more stable than vertical walls because gravitational forces “pull” walls into retained soil.

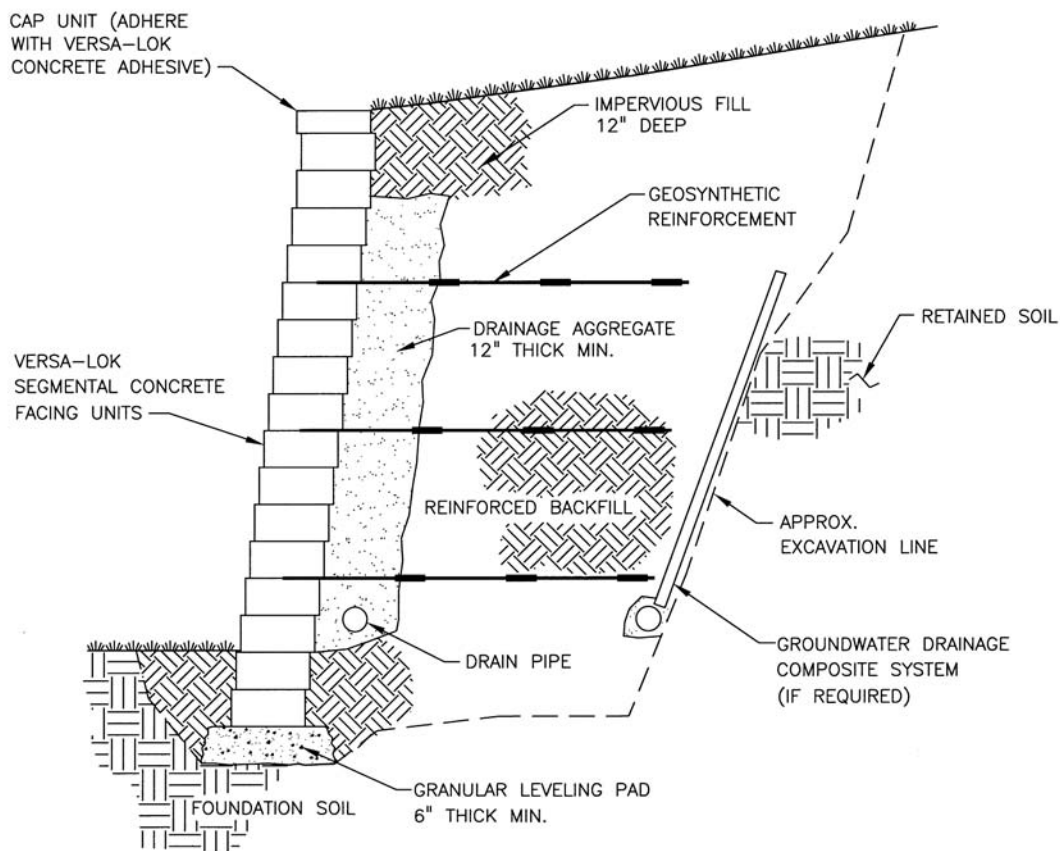

VERSA-LOK® Standard Wall Components

*Mortarless
VERSA-LOK
Standard retaining
walls do not
require rigid
concrete footings
below frost.*

Foundation

Foundation soils upon which segmental retaining walls will rest must be stiff, firm, and have sufficient capacity to support wall system weight. Any loose, soft or compressible material must be removed and replaced with properly compacted backfill. The bearing capacity of the foundation soils should be addressed by a soils engineer.

VERSA-LOK Standard retaining walls are installed on leveling pads consisting of coarse sand or well-graded angular gravel. The most commonly used material for leveling pads is that which is used locally as road base aggregate. Granular leveling pads provide stiff, yet somewhat flexible, bases to distribute wall weights.

Rigid concrete footings extending below frost are not required or recommended. Because Standard units are installed without mortar, they are free to move slightly in relation to each other. Flexibility of the leveling pads and wall units accommodates freeze/thaw cycles without damage to structures. VERSA-LOK Standard walls, installed on granular leveling pads, have been successfully used on projects throughout North America—including shoreline applications and walls exceeding 50 feet in height.



Compacted granular leveling pads provide a stiff but flexible base.

If a contractor chooses to form leveling pads using concrete, unreinforced pads should be made of lean concrete mix (200-300 psi) and no more than 2 inches thick. To ensure correct Standard unit alignment, special care needs to be taken to construct concrete pads that are exactly level. In rare situations where rigid, reinforced-concrete footings are required, they should be placed below seasonal frost depths.

VERSA-LOK® Standard Wall Components

Embedment

VERSA-LOK Standard segmental retaining walls usually have one-tenth of exposed wall heights embedded below grade. For example, a wall with 10 feet of height exposed above grade would have a minimum of 1 foot buried below grade—making a total wall height of 11 feet. Embedment should be increased for special conditions such as slope at the toe of walls, soft foundation soils, or shoreline applications. Embedment provides enhanced wall stability and long-term protection for leveling pads.

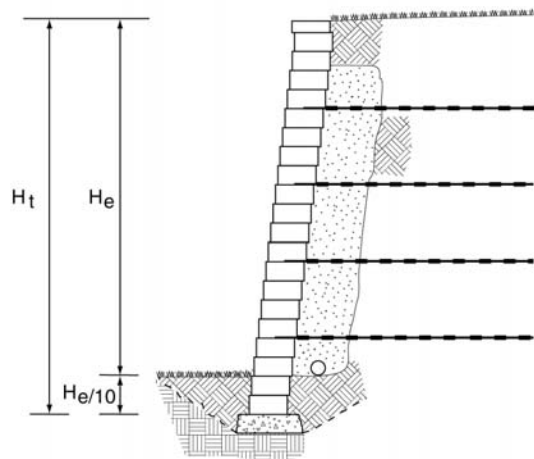

Soils and Compaction

With proper design, segmental retaining walls can be constructed within a wide variety of soil conditions. Granular soils are preferred as fill in the areas reinforced with geosynthetics; however, fine-grained soils such as clays are acceptable. Usually, coarse soils require less soil reinforcement and are easier to compact than fine soils. Problem materials like expansive clays, compressible soils, or highly organic soils (top soil) should be avoided or properly addressed in designs.

Proper compaction of foundation and backfill soil is critical to long-term performance of retaining wall systems. Loose backfill will add pressure on walls, collect water, cause settlement, and will not anchor soil reinforcement materials properly.

Foundation and backfill materials should be compacted to at least 95 percent of standard Proctor density. (Proctor density is the maximum density of the soil achieved in a laboratory using a standard amount of compaction effort.) Generally, construction observation and testing for proper soil type and compaction is provided by the project's soils engineer.

Properly compacted soils are critical to the performance of a VERSA-LOK Standard retaining wall.

Water should be directed away from walls with drainage structures.

Drainage Within Walls

Segmental retaining walls are designed assuming no hydrostatic pressure behind walls. Drainage aggregate (angular gravel, clear of fines) placed behind walls helps eliminate water accumulation. Because no mortar is used in VERSA-LOK Standard wall construction, water is free to weep through joints of installed units. For walls greater than 3 feet in height, a perforated drain pipe is recommended at the base of the drainage aggregate to quickly remove large amounts of water.

If high groundwater levels are anticipated or if the wall is along a shoreline, additional drainage materials behind and below reinforced fill may be required. Filter fabric may be required to prevent unwanted migration of fine soil particles into the drainage aggregate.

Surface Drainage

Wall sites should be graded to avoid water flows, concentrations or pools behind retaining walls. If swales are designed at the top of walls, properly line and slope them so water is removed before it can flow down behind walls.

Give special attention to sources of stormwater from building roofs, gutter downspouts, paved areas draining to one point, or valleys in topography. Be sure to guide flows from these areas away from retaining walls. Slope the soil slightly down and away from wall bases to eliminate water running along bases and eroding soil.

If finish grading, landscaping or paving is not completed immediately after wall installation, temporarily protect the wall from water runoff until adjacent construction and drainage control structures are completed.

VERSA-LOK® Standard Wall Components

Geosynthetic Reinforcement

Geosynthetics are durable, high-strength polymer products designed for use as soil reinforcement. Horizontal layers of geosynthetic provide tensile strength to hold the reinforced soil together, so it behaves as one coherent mass. The geosynthetic reinforced soil mass becomes the retaining wall. Sufficient length and strength of geosynthetic can create a reinforced soil mass large enough and strong enough to resist destabilizing loads. Geosynthetic layers also connect the VERSA-LOK Standard units to the reinforced soil.

Geosynthetics are made from several types of polymers that resist installation damage and long-term degradation. Geosynthetics are designed to interact with the soil for anchorage against pullout and resistance to sliding. Geogrids, the most common soil reinforcement for walls, are formed with an open, grid-like configuration. Geotextiles (solid fabrics) are also used. Product-specific testing determines the durability, soil interaction and strength of each type of geosynthetic. The interaction of various geosynthetics with Standard units (connection strength) is also thoroughly tested.

Geosynthetic layers must be nominally tensioned and free of wrinkles when placed. Geosynthetics are generally stronger in one direction—the roll direction. It is important that the high-strength direction be placed perpendicular to the wall face in one continuous sheet (no splices). Along the wall length and parallel to the face, adjacent sections of reinforcement are placed immediately next to each other without overlap to create 100 percent coverage with no gapping, and with special details for curves and corners. The required type, length, vertical spacing, and strength of geosynthetic vary with each project depending on wall height, loading, slopes and soil conditions. A professional Civil Engineer (P.E.) should prepare a final, geogrid-reinforced wall design for each project.

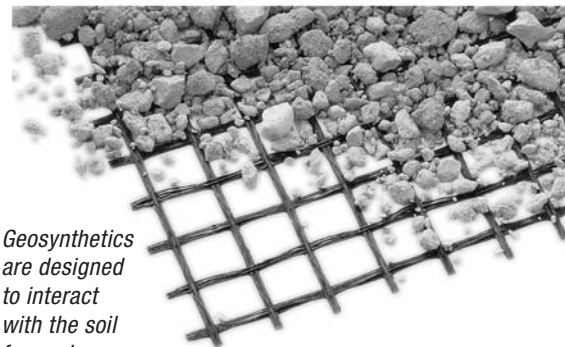

Geosynthetics are designed to interact with the soil for anchorage.

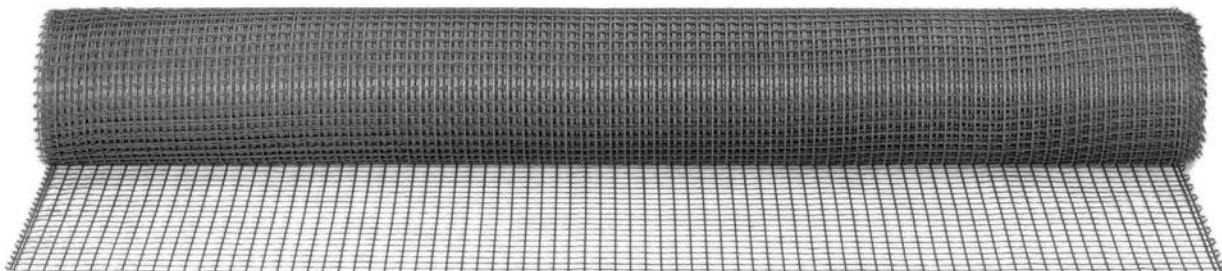

Geosynthetics provide tensile strength to backfilled soils.

Geosynthetics such as VERSA-Grid® reinforce backfill soils, allowing construction of stable VERSA-LOK Standard walls exceeding 50 feet in height.

VERSA-LOK® Standard walls are designed as traditional gravity walls. For unreinforced walls, the stabilizing weight of the battered wall units is compared to the loading on the walls to ensure stability against overturning and sliding (page 12, Figure 1A). When the loading exceeds the stability of the units alone, a larger gravity mass is created from reinforced soil (page 12, Figure 1B).

Loading on segmental walls is dependent on soil conditions, surcharges, slopes, water conditions and wall heights. Accurate knowledge of each of these properties is needed for a proper design. Soil properties required for a segmental retaining wall design include the internal friction angle (ϕ) and soil unit weight (γ). Generally, the cohesion (c) of any fine-grained soils is conservatively ignored to simplify the design.

To ensure stability of a reinforced retaining wall, the wall engineer must design the reinforced soil mass large enough to resist loads from outside the wall system (external stability) and with enough layers of proper strength geosynthetic to keep the reinforced soil mass together (internal stability). In addition, the design must have sufficient geosynthetic layers to keep units stable and properly connected to the reinforced soil mass (facial stability).

For internal stability, the wall designer can address potential overstress by using a higher

strength geogrid or adding more geogrid layers by reducing vertical space between geogrid layers. Potential pullout or internal sliding concerns can be addressed by lengthening the geogrid layers.

Internal compound stability is the potential for compound failures starting directly behind the wall, passing through the reinforced soil mass and exiting out the front face of the wall. The wall design engineer can address internal compound stability by using a higher strength geogrid type, adding geogrid layers, lengthening geogrid layers or improving the reinforced soil type.

For facial stability, the wall design engineer can address connection concerns by adding geogrid layers (including shorter supplementary layers) or using a higher connection strength geogrid.

For external stability, potential overturning or sliding both can be addressed by lengthening the geogrid layers to create a larger, more stable reinforced soil mass.

Evaluation of geotechnical concerns generally is the responsibility of the soils engineer. However, in some cases, these can be addressed by lengthening and strengthening the geogrid layers beyond what is required for the structural wall design.

Unreinforced Wall (Figure 1A)

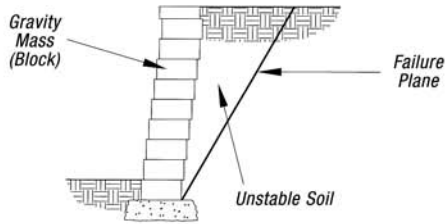

Reinforced Wall (Figure 1B)

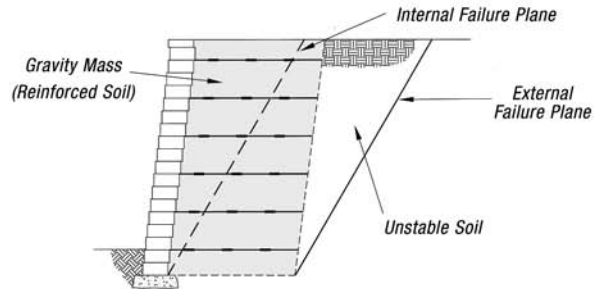

Internal Stability

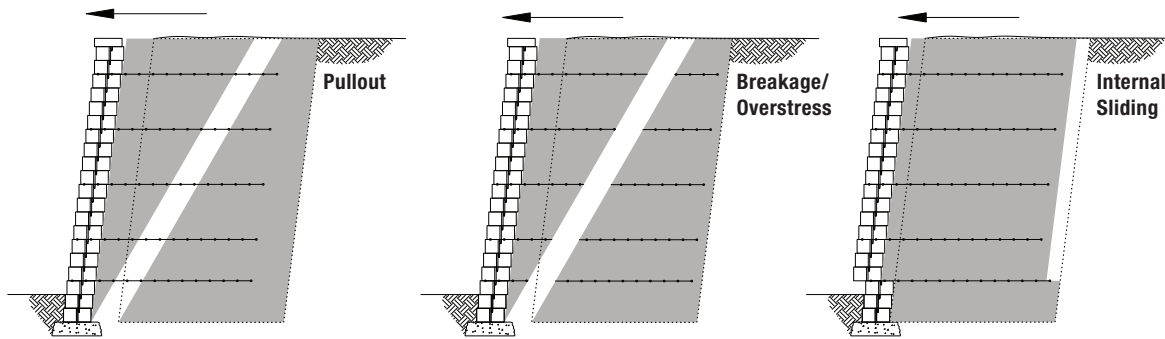

External Stability

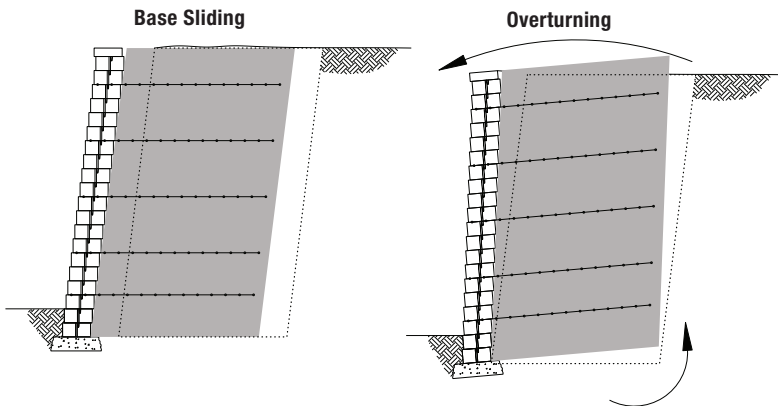

Internal Compound

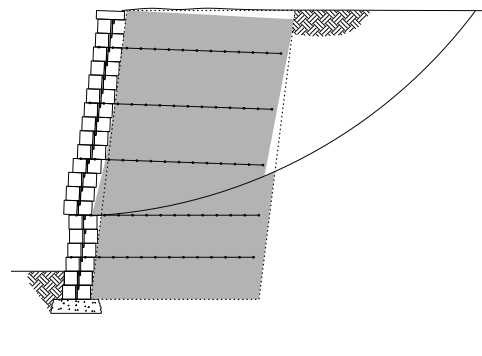

Geotechnical Concerns

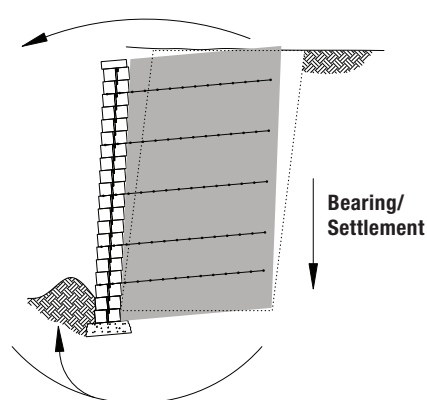
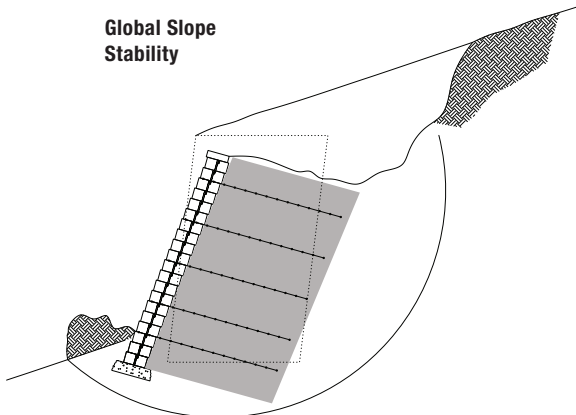

Special Design Considerations

With proper design and reinforcement, VERSA-LOK Standard walls can accommodate special site conditions such as water loads, slopes or surcharges.

Shorelines

VERSA-LOK® Standard retaining walls perform well in shoreline applications. However, special design considerations are often necessary to ensure that water pressures do not build up behind walls. Special provisions may include granular reinforced backfill, additional drainage aggregate, drainage behind reinforced soil masses and filter fabric. Protection of bases from water scour, wave action and ice may also be necessary.

See VERSA-LOK Technical Bulletin #1 for more information on shorelines and retention pond protection.



Loads Behind Walls

Surcharge loads behind walls can substantially increase amounts of required soil reinforcement. Common surcharge loads include parking areas, driveways, roads and building structures. For design purposes, permanent loads like buildings are considered to contribute to both destabilizing and stabilizing forces acting on walls. Dynamic forces like vehicular traffic are considered to contribute to destabilizing forces only.

Often, the highest surcharge loads are caused by grading or paving equipment during construction. Heavy equipment should be kept at least 3 feet behind the back of retaining wall units. Soil reinforcement designs should accommodate all anticipated surcharge loads—even if they will occur infrequently or just once.

Special Design Considerations



Slopes

Slopes behind walls increase pressures, sometimes doubling soil loads compared to level backfills. Steep slopes below walls can decrease stability of wall foundations. Slopes can increase the amount of soil reinforcement needed, especially the length. Generally, slopes above or below walls should be no steeper than 2:1 (horizontal:vertical).

Tiering

Aesthetically, it may sometimes be desirable to divide large grade changes into tiered wall sections. However, upper wall tiers can add surcharge loads to lower walls and necessitate special designs. To avoid loading lower walls, upper walls must be set back horizontally at least twice the height of the lower walls. If walls are placed closer, lower walls must be designed to resist the load of upper walls.



Several closely spaced tiered walls can create steep, unstable slopes. If tiered walls make a grade change steeper than 2:1 (horizontal: vertical), global slope stability may need to be reviewed by a qualified soils engineer.

See VERSA-LOK® Technical Bulletin #7 for more information on tiered wall construction.

When properly designed, tiered VERSA-LOK retaining walls will not only retain soil and support loads, but will also deliver an attractive appearance.

Planning, Estimating & Final Designs

The VERSA-LOK technical staff is available to assist in planning, layout, estimating and referrals for final engineering.

Planning

Prior to design, accurate information needs to be gathered, including soil conditions, proposed wall heights, topography, groundwater levels and surface water conditions. Proper permits, owner approvals, utility clearances and easements should also be obtained.

Make sure that layouts account for minimum curve radii, wall setback, and area needed for geosynthetic soil reinforcement. Be sure that all wall components fit within property constraints.

Verify that temporary construction excavations will not undermine foundation supports of any existing structures or utilities. Considerations should also be given to site access for equipment and materials.

Estimating

Accurately estimate and order required materials including VERSA-LOK Standard units, VERSA-TUFF Pins, VERSA-LOK Cap units, VERSA-LOK Concrete Adhesive, imported backfill, leveling pad materials, geosynthetic soil reinforcement and drainage materials. See the Materials Estimation Worksheet on page 31 to help determine VERSA-LOK product quantities. For reinforced-wall projects, the VERSA-Grid® estimating charts on page 32 provide approximate amounts of geogrid soil reinforcement necessary to construct walls in various soil and loading conditions. For tall walls or complex situations, VERSA-LOK staff engineers can prepare project specific preliminary designs to be used for estimation purposes.

Final Designs

Final wall designs may be provided prior to putting projects out for bidding. Alternatively, projects can be specified design/build. With design/build projects, the specifiers provide wall layout information (line and grade) but not final engineering for the wall. Contractors submit bids based on this layout including estimated labor, materials and final engineering costs. Contractors who are awarded projects retain licensed engineers to prepare final wall designs.

A soils report prepared by a qualified geotechnical engineer is needed to provide information on reinforced and retained properties. The soils report should also address slope stability and bearing capacity of foundation soils.

Design/build specifications and sample construction details are provided on pages 33 to 46. This information, along with additional details, is available in electronic format on the VERSA-LOK Specifiers' Binder CD or on the VERSA-LOK website at www.versa-lok.com.

For walls more than 4 feet in height, most building codes require a final wall design prepared by a licensed Civil Engineer (P. E.) registered in that state. VERSA-LOK and its manufacturers have a network of licensed civil engineers who are familiar with segmental retaining wall design. These individuals are available for referrals to architects, engineers or contractors with final wall design needs.

Wall Construction

Tools

The following tools may be helpful during construction of VERSA-LOK Standard Retaining Wall Systems.

VERSA-LIFTER®

Safety Protection

Shovel

4-Foot Level

Smaller Level

4-Pound Sledge Hammer

Masonry Chisel

Brick Hammer

Tape Measure

Hand Tamper

Vibratory-Plate Compactor

Caulking Gun

Stringline

Finishing Trowel

Broom

Diamond-Blade Concrete Saw

Hydraulic Splitter

Transit or Site Level

Backhoe or Skid-Steer Loader



The VERSA-Lifter makes it easier to lift and place units—especially on the base course. Two prongs on the lifter are inserted into pin holes in each Standard unit. Lifting the handle secures the lifter to the unit and makes for easy, balanced lifting and placement.

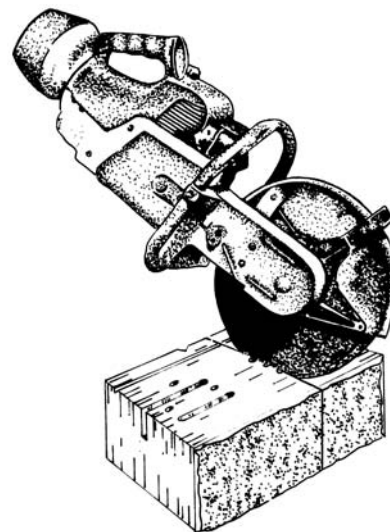

VERSA-LOK® Standard Wall Construction

VERSA-LOK Standard units are easily modified by splitting for a textured face, or by saw-cutting for a smooth side.

Unit Modification

During wall construction, it will sometimes be necessary to split or cut VERSA-LOK Standard units. Splitting will create attractive, textured surfaces-similar in appearance to front faces of units. Saw-cutting will produce smooth, straight surfaces. In general, units are split when modified portions will be visible. Units are cut when straight edges are required to fit closely next to smooth edges of adjacent units.

Splitting

To split a
VERSA-LOK

Standard unit by hand, mark desired path of split on unit top, bottom and back. Score along the top and bottom paths using a 2- to 3-inch masonry chisel and heavy hammer. Next, place the unit on its face and strike along the back path. It is easier to split units on the ground than on a hard surface. Unit should fracture nicely along paths. If many splits will be required for a project, it may be helpful to rent a mechanical or hydraulic splitter.

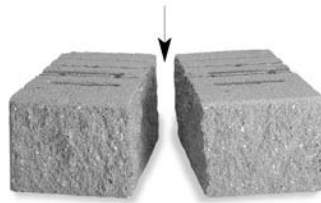

Saw-Cutting

Saw-cuts are normally made using a gas-powered cut-off saw with a diamond blade. To cut a VERSA-LOK Standard unit, mark desired path of cut on all unit sides. On a stable work surface, place the unit face toward you with the top side up, at a comfortable height. Make a straight cut down and 2 to 3 inches into the face. Move the saw to the top of unit, and cut through top using successively deeper cuts. Flip unit over and finish by cutting completely through the bottom of the unit.

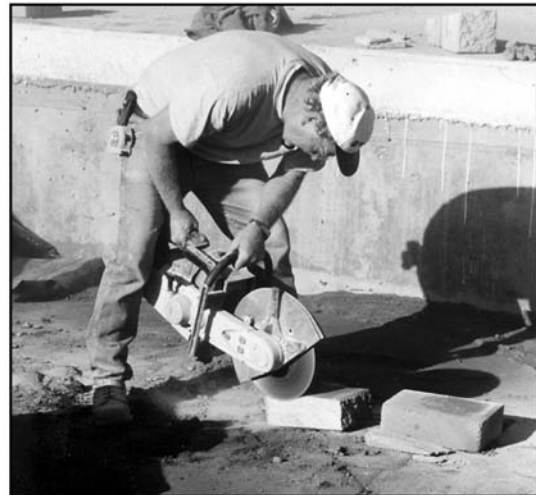

If a cut-off saw is not available, a common circular saw and an inexpensive masonry blade may be used. Cut 1 to 2 inches deep along the path on the front face. Split the remainder of the unit. The vertical cut on the face of the unit will fit closely against adjacent units - the split portion will not be visible.

VERSA-LOK® Standard Wall Construction

Excavation

Excavate just deep enough to accommodate the leveling pad (usually 6 inches) and required unit embedment below grade. When necessary, also excavate areas where geosynthetic soil reinforcement will be placed. Required unit embedment varies with wall height and site conditions. Generally, if grade in front of the wall is level, one-tenth of the exposed wall height should be buried (embedded) below grade. Additional embedment may be required for special conditions, including slopes in front of walls, soft foundation soils and water applications.

Compact soil at the bottom of excavation.

Do not place wall system on loose, soft, wet or frozen soil—settlement may result. If the wall will sit on previously backfilled excavations such as utility line trenches, be sure the entire depth of existing backfill is well-compacted. If necessary, over-excavate soft soils and replace with properly compacted backfill.

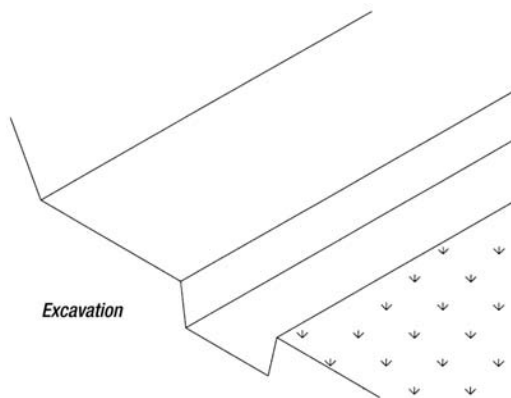

Leveling Pad

Place granular leveling pad material and compact to a smooth, level surface. Leveling pad should be at least 6 inches thick and 24 inches wide. It should consist of coarse-grained sand, gravel, or crushed stone. Use a thin layer of fine sand on top of the leveling pad for final leveling.

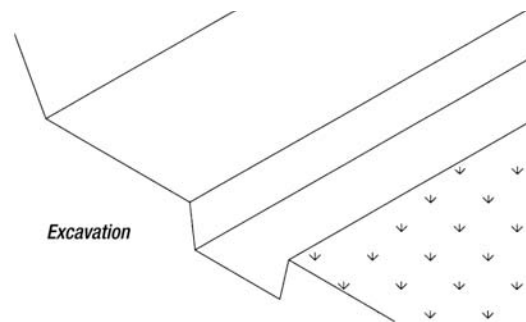

To quickly construct long sections of leveling pad, create forms by leveling and staking rectangular metal tubing along both sides of the planned pad. Place and compact granular material within these leveled forms and screed off excess.

See VERSA-LOK Technical Bulletin #5 for more tips about leveling pad construction.

If the planned grade along the wall front will change elevation, the leveling pad may be stepped in 6-inch increments to match the grade change. Always start at the lowest level and work upward.

Step the leveling pad often enough to avoid burying extra units while maintaining required unit embedment.

Carefully plan the location and alignment of the wall base to ensure top of wall will be at desired location.

VERSA-LOK® Standard Wall Construction

Base Course

Make sure that the leveling pad is level and begin placing base course units. If the leveling pad is stepped, begin at the lowest point and place entire length of lowest course before proceeding to next course.

Take time to ensure a level base course—minor unevenness in the base course will be amplified and difficult to correct after several courses have been installed.

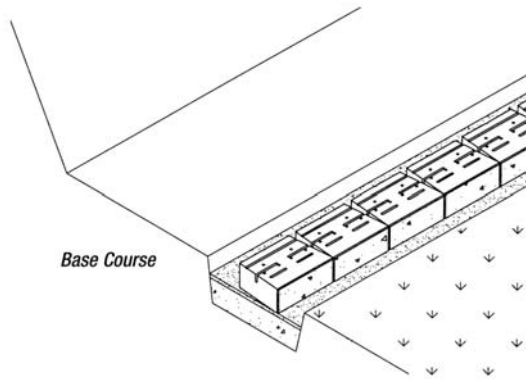

Using a 4-foot level, level units front to back, side to side, and with adjacent units. Tap high points with a mallet or hand tamper until level. Take time to ensure a level base course. Minor unevenness in the base course will be amplified and difficult to correct after several courses have been installed.

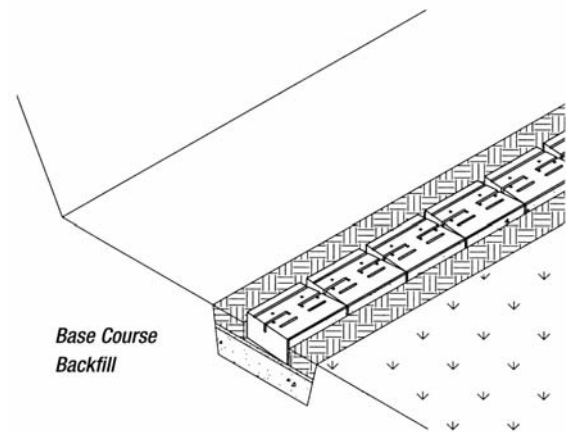

After base course has been positioned, place and compact soil backfill behind the units. Also replace and compact over-excavated soil in front of units at this time. Backfill behind and in front of embedded units should consist of soil—do not use drainage aggregate.

Align units using their backs or slots rather than their irregularly textured front faces. Stringlines may be helpful when aligning straight walls. Refer to pages 25, 26 and 27 for tips on curve and corner alignment. Place units side by side on the leveling pad. Front faces of adjacent units should fit tightly and unit bottoms should contact the leveling pad completely.

VERSA-LOK® Standard Wall Construction

Additional Courses

Sweep off tops of installed units to remove any debris that may interfere with additional courses. Place next course so that the units are set back 3/4-inch from faces of installed units. Set the units a short distance away from their final position and slide them into place. Sliding helps remove imperfections and debris from the top surface of installed units.

The unique VERSA-LOK hole-to-slot pinning system allows Standard units to be installed on variable bond. (Units do not need to be placed exactly halfway over the two lower course units.)

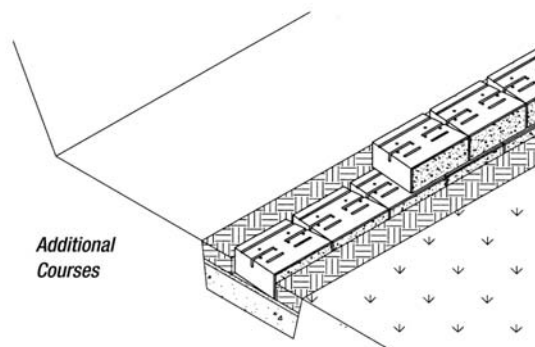

Vertical joints can wander in relation to other joints throughout walls. However, units should generally overlap adjacent lower course units by at least 4 inches to aid structural stability. Do not try to install walls on half bond by leaving gaps in vertical face joints. Because the bond can vary, vertical face joints can and should be tight.

Insert two VERSA-TUFF® Pins through the front holes of the upper-course units into the receiving slots in the lower-course units. There are four

front holes in each unit, but only two are used. Use the two outside holes when possible. If one of the outside holes is not usable, move pin to next closest hole. The two pins should engage two separate units in the lower course. Make sure the pins are fully seated in the lower unit slots. If necessary, seat pins using a mallet and another pin. Pins are fully seated when they are recessed approximately 1 inch below the top surface of upper units.

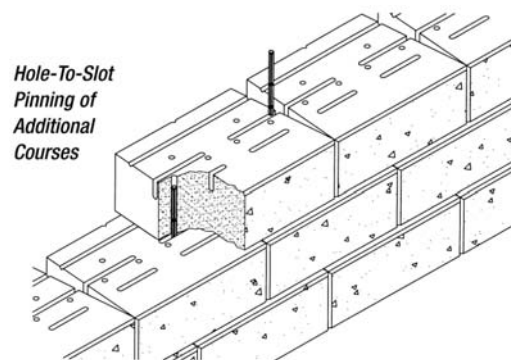

Pull the units forward to remove any looseness in the pin connection. Check unit alignment and levelness—adjust if necessary. If the length of a course must fit into a limited space or if vertical joints begin to line up with joints in the course immediately below, adjust by installing partial units. Create partial units by saw-cutting whole units into pieces at least 4 inches wide at the front face. When installing partial units, try to disperse them throughout the wall. This technique helps to hide partial units and lends to a more attractive project.

Stack no more than three courses before backfilling. If VERSA-LOK Standard units are stacked too high, they may push out of alignment during placement of backfill.

The unique hole-to-slot pinning system allows VERSA-LOK Standard units to be installed on variable bond.

VERSA-LOK® Standard Wall Construction

Drainage Materials

Beginning at the level of planned grade in front of the wall, place drainage aggregate (3/4-inch clear, free-draining, angular gravel) between and directly behind units to a minimum thickness of 12 inches. Drainage aggregate must be free of fine dirt or soil. Do not place drainage aggregate behind units that will be embedded. Drainage aggregate is critical to wall performance because it keeps water pressures from building up behind the wall face.



For walls over 3 feet high, perforated drain pipes should be used to collect water along the base of the drainage aggregate. Drain pipes help to quickly remove large amounts of water. For some projects, often shoreline applications, a geosynthetic filter fabric may be required behind the drainage aggregate. Filter fabric will prevent soils or sands (fines) from migrating into the drainage aggregate and wall face joints.

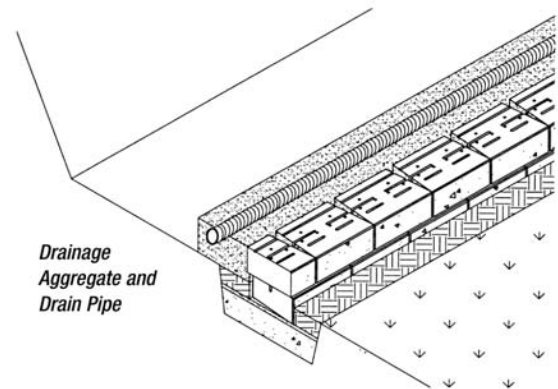

Compacted Soil Backfill

Proper placement and compaction of backfill is critical to the stability of a segmental wall. Poorly compacted backfill puts extra pressures on a wall—especially when it becomes wet.

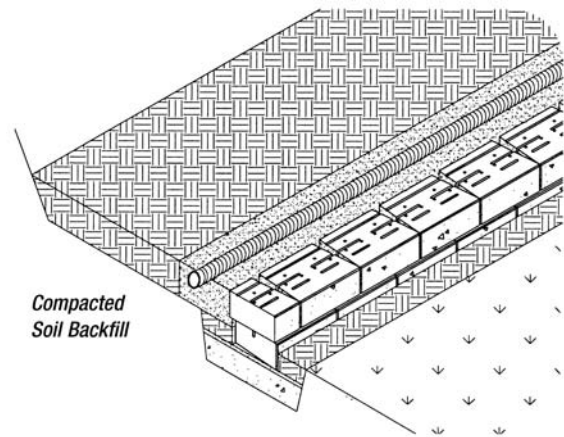

Place soil backfill beginning directly behind drainage fill in layers (lifts) no thicker than 6 inches. Compact soil backfill—making sure that backfill is not too wet nor dry. The amount and type of effort needed for adequate backfill compaction varies with soil type and moisture content. Generally, hand-operated vibratory-plate compactors can be used to achieve adequate

VERSA-LOK® Standard Wall Construction

compaction of granular soils—even on big projects. Fine soils such as clays should be compacted with kneading-type equipment like sheepfoot rollers.

To avoid pushing wall units out of alignment, do not use heavy self-propelled compaction equipment within 3 feet of the wall face.

At the end of the day's construction, protect the wall and the reinforced backfill from possible rainstorm water damage. Grade the soil backfill so water will run away from wall face and direct runoff from adjacent areas away from project site.

Geosynthetic Soil Reinforcement

Geosynthetic soil reinforcement such as VERSA-Grid® is used to reinforce soil backfill when the weight of Standard units alone is not enough to resist soil pressures. Soil reinforcement type, length and vertical spacing will vary for each project and should be specified in a final wall design prepared by a licensed Civil Engineer (P.E.).

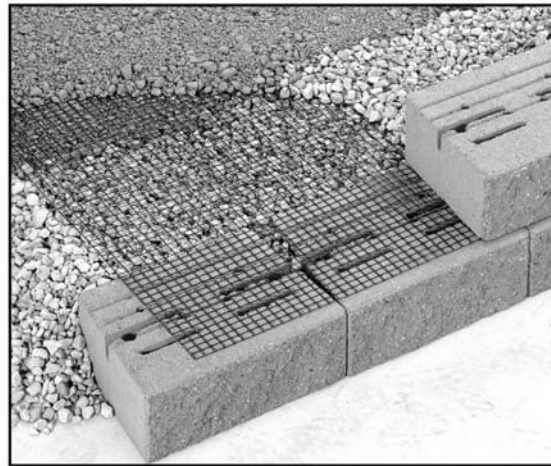
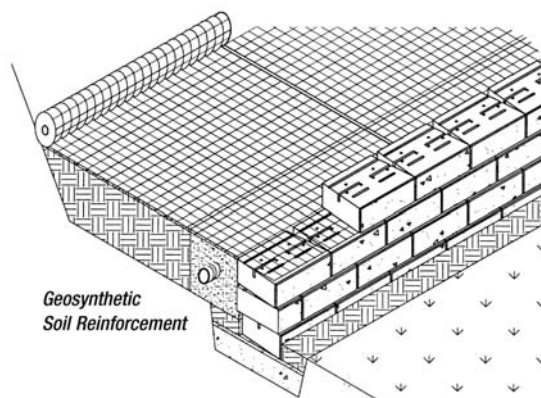

The strongest direction of the geosynthetic (almost always the roll direction) must be perpendicular to the wall face.

Prepare to install soil reinforcement materials by placing Standard units and backfilling up to the height of the first soil reinforcement layer specified on construction drawings.

Lay soil reinforcement horizontally on top of compacted backfill and the Standard units. Geosynthetic layers should be placed about 1 inch from the front of the Standard units.

Geosynthetics are usually stronger in one direction. It is very important to place them in the correct direction. The strongest direction of the geosynthetic must be perpendicular to the wall face. For correct orientation, follow the geosynthetic manufacturer's directions carefully.

After positioning soil reinforcement, place the next course of Standard units on top of soil reinforcement. Insert pins through Standard units and into lower-course units. Place drainage aggregate against back of the units and on top of soil reinforcement. Remove slack by pulling soil reinforcement away from the wall face and anchoring at back ends. Beginning at the wall

VERSA-LOK® Standard Wall Construction

Proper backfill compaction is critical to the stability of a segmental retaining wall.

face, place and compact soil backfill. Keep soil reinforcement taut and avoid wrinkles. Place a minimum of 6 inches of soil backfill before using any tracked equipment on top of soil reinforcement. Follow manufacturer's construction guidelines to avoid damage to soil reinforcement.

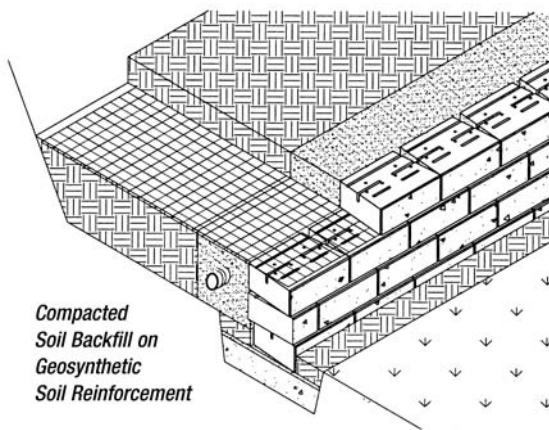

Placing soil reinforcement behind curves and corners requires special layout and overlapping procedures. Never overlap soil reinforcement layers directly on top of each other. Slick surfaces of geosynthetics will not hold in place properly when placed directly on top of one another. Always provide at least 3 inches of soil fill between overlapping soil reinforcement layers.

While spacing of geogrid will vary, to ensure stability during construction, vertical spacing between geosynthetic layers should never exceed 2 feet. See VERSA-Grid® estimating charts on page 32 for assistance with preliminary material estimating.

More, More, More...

Continue placing additional courses, drainage material, compacted soil backfill and geosynthetic soil reinforcement as specified until desired wall height is achieved. For walls more than 4 feet high, most building codes require a final wall design prepared by a licensed Civil Engineer (P. E.) registered in that state. VERSA-LOK and its manufacturers have a network of licensed civil engineers who are familiar with segmental retaining wall design. These individuals are available for referrals to architects, engineers, or contractors with final wall design needs.



VERSA-LOK® Standard Wall Construction

Caps

Finish the wall by placing cap units along the top. Two VERSA-LOK Cap unit types are available—A and B. Alternate A and B caps on straight walls. Use A caps for convex (outside) curves. Use B caps for concave (inside) curves.

If cap layout does not exactly match the wall radius, adjust spacing at the back of the caps—do not gap caps at the front. To completely eliminate gapping, it may be necessary to saw-cut sides of cap units.

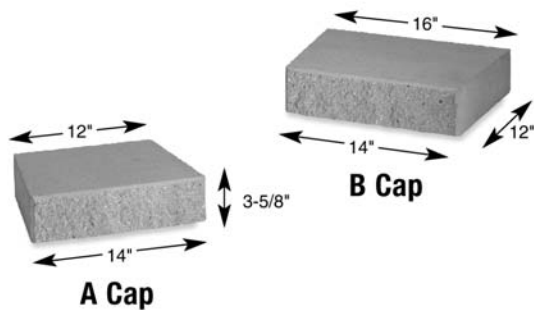

Front faces of caps may be placed flush, set back, or slightly hung over faces of VERSA-LOK Standard wall units. It is preferred to overhang cap units approximately 3/4 inch to create an “eyebrow” on top of the wall. Overhanging cap units will create a small shadow on wall units and help to hide minor imperfections in wall alignment.



All cap units should be arranged before securing with VERSA-LOK Concrete Adhesive. Secure caps by placing two continuous 1/4-inch beads of adhesive along the top course of wall units. Set caps on prepared wall units. Do not secure caps using mortar or adhesives that become rigid. A VERSA-LOK wall may move slightly (especially in areas subject to freeze/thaw cycles), causing a rigid cap adhesive to fail. Do not place caps if the units are too wet for the adhesive to stick. In cold weather, keep the adhesive tubes warm until just prior to use.

For more information about capping, see VERSA-LOK Technical Bulletin #4.

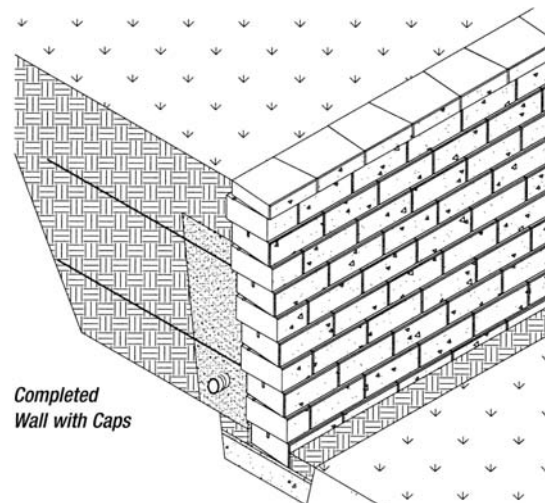

Basic Wall Design Elements

VERSA-LOK Standard is easily installed in curves without special modifications.

Curves

The trapezoidal shape of VERSA-LOK® Standard units permits construction of concave, convex and serpentine curves. General construction requirements described earlier in this guide (leveling pad preparation, drainage, compaction) remain the same for curve installation. All radii distances below are measured from circle centers to front of unit faces.

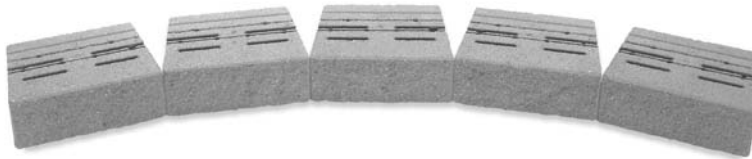

Inside Curve

Concave curves are constructed by increasing spaces between backs of adjacent units—always keeping front joints tightly aligned. Concave curves may be built at any radius; however, a minimum radius of 6 feet is recommended. Radii smaller than 6 feet are structurally adequate but tend to appear choppy. Often, it is more appropriate to build inside corners instead of tight concave curves.

Convex curves are constructed by decreasing spaces between backs of adjacent units. Because upper courses of VERSA-LOK Standard units are set back from lower courses by several inches, course radii become smaller as walls become taller. If a course radius becomes too small, Standard units cannot be properly positioned without cutting unit sides. Therefore, careful base course planning for convex curves is important when building tight curves.

Minimum top course radius for convex curves is 8 feet. To calculate correct base course radius, add 3/4 inch for each wall course to the minimum radius. For example, minimum base course radius for a wall that will have six setbacks (including embedded units) will be $(6 \times 3/4") + 8' = 8' + 4-1/2"$.

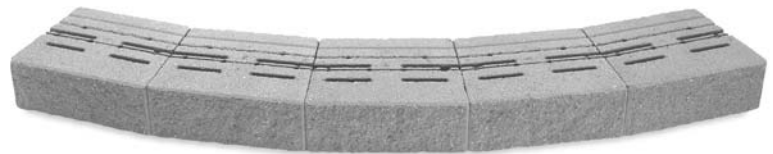

Outside Curve

See VERSA-LOK Technical Bulletin #3 for more curve details, including proper placement of geosynthetic soil reinforcement.

Basic Wall Design Elements

Corners

VERSA-LOK® Standard units may be easily used to create an unlimited variety of corners.

Outside 90-degree corner units are easily created by splitting Standard units in half. Alternate half units as shown above. This creates about a 4-inch overlap of the units below. This is acceptable - Standard units do not need to be exactly halfway over the lower units (half-bond) as explained on page 20.



Outside 90 Degree

The one Standard unit permits construction of a variety of corners.



Inside 90 Degree

Half units on outside 90-degree corners do not pin. Instead, secure them using VERSA-LOK Concrete Adhesive.

No unit modification is necessary to install inside 90-degree corners. Place full-size Standard units as shown, adjusting for proper vertical joint arrangement.

See VERSA-LOK Technical Bulletin #3 for more corner details, including proper placement of geosynthetic reinforcement for corners.

Basic Wall Design Elements

VERSA-LOK
Standard corners
overlap to
structurally
interlock walls
meeting at
corners.

Corners

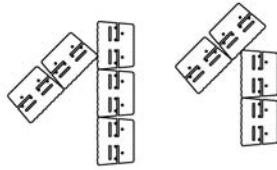

LOW ANGLE, INSIDE

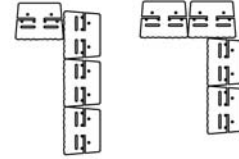

RIGHT ANGLE, INSIDE

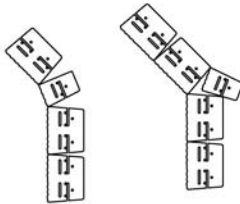

LARGE ANGLE, INSIDE

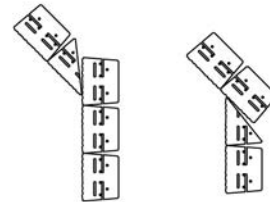

LARGE ANGLE, INSIDE (OPT.)

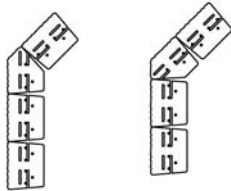

LARGE ANGLE, OUTSIDE

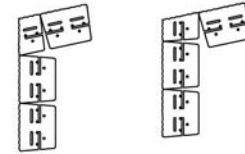

NEAR RIGHT ANGLE, OUTSIDE

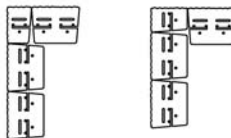

RIGHT ANGLE, OUTSIDE

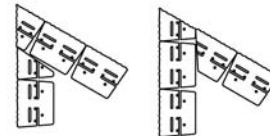

LOW ANGLE, OUTSIDE

The figures above illustrate a variety of inside and outside corner arrangements. Use these illustrations as guides when designing unique corners. Note that illustrations represent alternating courses and that VERSA-LOK Standard units are modified to create corner units. Split units where textured faces are desired and

visible. Saw-cut units when straight edges are needed to fit closely next to adjacent units.

Alternating corner units should overlap - do not butt or miter corners. If corners are butted or mitered, differential movement between "separate walls" can occur.

Basic Wall Design Elements

Stepped Base Elevations

If the final grade along the front of the wall changes elevation, the leveling pad and base course may be stepped in 6-inch increments to match the grade change. Always start at the lowest level and work upward.

Step the leveling pad often enough to avoid burying extra Standard units while maintaining required unit embedment.

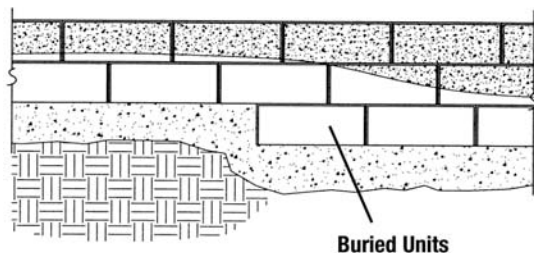

See *VERSA-LOK® Technical Bulletin #5* for more information on stepped base and wall-top installation.

Stepped Wall Tops

Wall tops should step to match grade changes. As a wall steps down, use split half-units to end each course. Split units provide textured sides to match the wall face.

When capping tops of stepped walls, split the exposed side of the last cap unit to create an attractive end.

Returns

As an option to stepping wall tops, grade changes at the top of a wall can be accommodated by creating returns that turn into slopes behind a wall.

Returns create a terraced appearance instead of several small steps along the top of a wall.

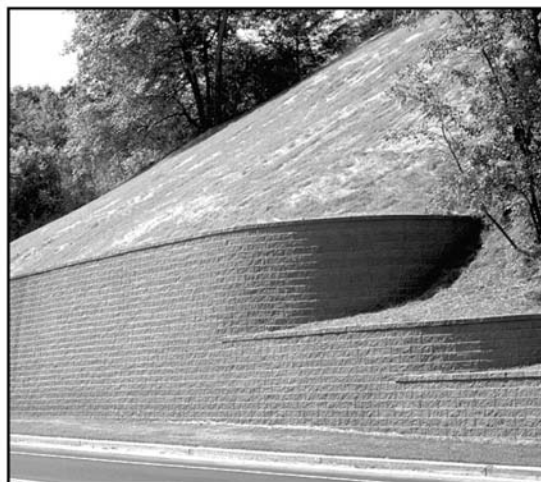

Stepped Wall Top with Caps

The top of VERSA-LOK Standard walls can step down in 6-inch increments or in larger steps created by returns.

Advanced Wall Features

VERSA-LOK® Standard units with VERSA-LOK Caps as treads can be used to create a variety of attractive stairs.



Stairs

Stairs with a ratio 2:1 (horizontal:vertical) can be easily installed using VERSA-LOK® Standard units. Recommended step construction begins by stacking a pedestal of Standard units. Cap units are then placed as treads and vertical sidewalls are installed.

See VERSA-LOK Technical Bulletin #2 for detailed stair installation instructions.

Freestanding Walls

Installers also can use Standard units to create freestanding walls that are exposed on both sides (walls that do not retain any soil). Splitting units at the rear grooves, parallel to the back of the units, creates textured faces on the backs of the unit that match the front split face. These modified units are arranged to create a straight, vertical wall with textured faces on both of the exposed sides of the wall. For stability, freestanding walls should not exceed 3 feet high.



See VERSA-LOK Technical Bulletin #6 for more information.

Advanced Wall Features



Columns

A wide variety of attractive columns can be easily created from VERSA-LOK® Standard units. Columns less than 4 feet high can be supported on granular leveling pads with no frost footings, just like VERSA-LOK Standard retaining walls. The simplest column is created by splitting Standard units into half-units and vertically stacking them in a 20-inch by 20-inch square column. However, columns of other sizes are also possible with unit modification.

For stability, taller columns require cast-in-place concrete footings. The center hole of the columns (behind the units) can be used to install steel-reinforced concrete to stabilize taller columns. A qualified professional Civil Engineer should provide a design for columns over 4 feet high.

See VERSA-LOK Technical Bulletin #6 for more information.

Guide Rails, Railings and Traffic Barriers

For safety purposes, a variety of barriers may be placed behind VERSA-LOK Standard walls, including fences, railings and guide rails.

Barriers should be placed several feet behind wall faces to provide post foundations. Posts may penetrate geosynthetic soil reinforcement layers in accordance with the manufacturer's and engineer's recommendations.

When space is limited, properly designed, reinforced concrete barriers can be placed directly on top of walls. Expansion joints and bond breaks should be provided to accommodate differential movement between rigid barriers and flexible wall faces. Cantilevered supports extending behind walls stabilize the barriers against overturning.



For more information about guide rails, railings and traffic barriers see VERSA-LOK Technical Bulletin #8 or VERSA-LOK Standard and Mosaic® Construction Details CD-Rom—available FREE by calling (800) 770-4525 or online at: www.versa-lok.com.

Material Estimation Worksheet

VERSA-LOK® Standard Units

Area of Wall (SF) x 1.5 Units per SF = Number of Standard Units

_____ SF x 1.5 = Units Needed

VERSA-TUFF® Pins

Units x 2 Pins per Unit = Number of Pins

_____ Units x 2 = _____ Pins Needed

(Base course of VERSA-LOK Standard units does not require pins.)

VERSA-LOK Caps

Lineal Feet of Wall (LF) x .86 = Number of Caps

_____ LF x .86 = _____ Caps Needed

straight walls - use half **A** caps and half **B** caps

inside curves - use **B** caps

outside curves - use **A** caps

Additional caps may be needed for special splits or cuts.

Gradual curves may require a combination of A & B caps.

VERSA-LOK Concrete Adhesive

11 oz. Tube: _____ LF ÷ 14 LF per Tube = _____ Tubes

VERSA-Grid®

For estimating purposes, the tables on the following page provide approximate amounts of VERSA-Grid soil reinforcement needed to construct walls in certain soil and loading conditions. For tall walls or complex situations, VERSA-LOK staff engineers can prepare project specific preliminary designs to be used for estimation purposes.

VERSA Grid® Estimation Charts

These tables are provided for **estimating purposes only**. They should not be used or relied upon for any application without verification of accuracy, suitability and applicability for the use contemplated, which is the sole responsibility of the user. A final, project-specific design should be prepared by a qualified, licensed, professional Civil Engineer (P.E.) based on actual site conditions. Preparation of these tables did not include consideration or analysis of global slope stability or allowable bearing capacity of foundation soils. These must be reviewed for each project by a qualified Geotechnical Engineer.

There are three tables provided in this guide to help estimate geogrid for different wall loading situations - level backfill, sloping backfill and surcharges. To estimate geogrid quantities, first look under the **column** appropriate for project soils, determine the height (H) of the proposed wall and read across the **row** (under appropriate soil column) to approximate geogrid type, number of layers and lengths of each layer.

These design charts assume the following conditions:

- Uniform soil conditions
- Stable foundation soils
- Level grade in front of the wall
- No groundwater/water loads
- Slopes and loads behind the wall as shown
- No additional loading behind wall (such as tiered walls, building loads, etc.)

Design standards and properties used to develop these charts were:

- Design methodology in general accordance with NCMA Design Manual for SRWs
- Unit weight of soil (γ) 120 pcf
- Internal friction angle of soil (ϕ) as shown on charts
- Long-term design strength of the geogrid (LTDS)
- **VERSA-Grid VG 3.0 - 1250 lb/ft**
- **VERSA-Grid VG 5.0 - 1875 lb/ft**

Level Backfill

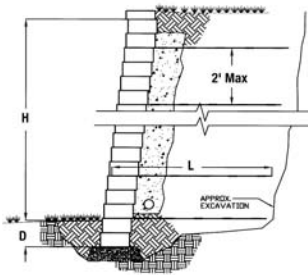

Gravel ($\phi = 34^\circ$)

H (feet)	D (feet)	L (feet)	layers	VERSA-Grid
4	0.5	0	0	n/a
5	0.5	3.5	2	VG 3.0
6	0.5	4.0	2	VG 3.0
7	1.0	5.0	3	VG 3.0
8	1.0	5.5	4	VG 3.0
9	1.0	6.0	4	VG 3.0
10	1.0	6.5	5	VG 3.0
12	1.0	8.0	6	VG 3.0

Sand ($\phi = 30^\circ$)

H (feet)	D (feet)	L (feet)	layers	VERSA-Grid
4	0.5	4.0	1	VG 3.0
5	0.5	4.0	2	VG 3.0
6	0.5	4.5	2	VG 3.0
7	1.0	5.5	3	VG 3.0
8	1.0	6.0	4	VG 3.0
9	1.0	6.5	5	VG 3.0
10	1.0	7.0	5	VG 3.0
12	1.0	8.5	7	VG 3.0

Clay ($\phi = 28^\circ$)

H (feet)	D (feet)	L (feet)	layers	VERSA-Grid
4	0.5	4.0	1	VG 3.0
5	0.5	4.5	2	VG 3.0
6	0.5	5.0	2	VG 3.0
7	1.0	5.5	3	VG 3.0
8	1.0	6.0	4	VG 3.0
9	1.0	6.5	5	VG 3.0
10	1.0	7.0	6	VG 3.0
12	1.0	8.5	7	VG 3.0

Sloping Backfill

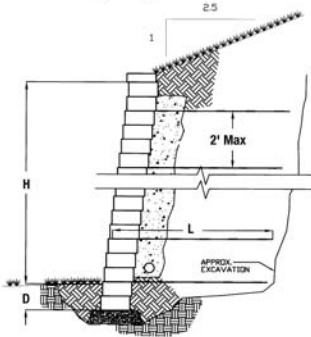

Gravel ($\phi = 34^\circ$)

H (feet)	D (feet)	L (feet)	layers	VERSA-Grid
4	0.5	4.0	1	VG 3.0
5	0.5	4.0	2	VG 3.0
6	0.5	4.5	3	VG 3.0
7	1.0	5.5	4	VG 3.0
8	1.0	6.0	4	VG 3.0
9	1.0	6.5	5	VG 3.0
10	1.0	7.5	6	VG 3.0
12	1.0	8.5	7	VG 3.0

Sand ($\phi = 30^\circ$)

H (feet)	D (feet)	L (feet)	layers	VERSA-Grid
4	0.5	4.5	1	VG 3.0
5	0.5	4.5	2	VG 3.0
6	0.5	5.5	3	VG 3.0
7	1.0	6.5	4	VG 3.0
8	1.0	7.0	5	VG 3.0
9	1.0	8.0	6	VG 3.0
10	1.0	8.5	6	VG 3.0
12	1.0	10.0	7	VG 5.0

Clay ($\phi = 28^\circ$)

H (feet)	D (feet)	L (feet)	layers	VERSA-Grid
4	0.5	4.5	2	VG 3.0
5	0.5	5.5	2	VG 3.0
6	0.5	6.0	3	VG 3.0
7	1.0	8.0	4	VG 3.0
8	1.0	9.5	5	VG 3.0
9	1.0	11.0	6	VG 3.0
10	1.0	12.0	6	VG 5.0
12	1.0	15.0	7	VG 5.0

Surcharge Backfill

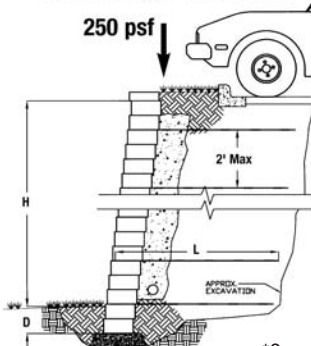

Gravel ($\phi = 34^\circ$)

H (feet)	D (feet)	L (feet)	layers	VERSA-Grid
4	0.5	4.0	2	VG 3.0
5	0.5	4.5	2	VG 3.0
6	0.5	5.0	3	VG 3.0
7	1.0	6.0	4	VG 3.0
8	1.0	6.5	4	VG 3.0
9	1.0	7.0	5	VG 3.0
10	1.0	7.5	5	VG 3.0
12	1.0	9.0	7	VG 3.0

Sand ($\phi = 30^\circ$)

H (feet)	D (feet)	L (feet)	layers	VERSA-Grid
4	0.5	4.5	2	VG 3.0
5	0.5	5.5	2	VG 3.0
6	0.5	6.0	3	VG 3.0
7	1.0	7.0	4	VG 3.0
8	1.0	7.5	5	VG 3.0
9	1.0	8.5	5	VG 3.0
10	1.0	9.0	6	VG 3.0
12	1.0	10.0	7	VG 5.0

Clay ($\phi = 28^\circ$)

H (feet)	D (feet)	L (feet)	layers	VERSA-Grid
4	0.5	5.5	2	VG 3.0
5	0.5	6.0	2	VG 3.0
6	0.5	6.5	3	VG 3.0
7	1.0	7.5	4	VG 3.0
8	1.0	8.0	5	VG 3.0
9	1.0	9.0	5	VG 3.0
10	1.0	9.5	6	VG 3.0
12	1.0	11.0	7	VG 5.0

*Geogrids with similar LTDS and connection strengths to VERSA-LOK® units can also be estimated using these charts.

With some variations, the VERSA-Grid VG 3.0 charts also generally estimate quantities for Miragrid 3XT, Stratagrid 200, and Raugrid 4/2. The charts for VERSA-Grid VG 5.0 generally estimate quantities for Miragrid 5XT, Stratagrid 350, and Raugrid 6/3.

Miragrid is a registered trademark of Nicolon Corporation. • Stratagrid is a registered trademark of Strata Systems, Inc.
Raugrid is a trademark of Luckenhaus Technische Textilien GmbH and Luckenhaus North America, Inc.

VERSA-LOK® Specifications

PART 1: GENERAL

1.01 DESCRIPTION

A. *Work includes furnishing and installing segmental retaining wall (SRW) units to the lines and grades designated on the project's final construction drawings or as directed by the Architect/Engineer. Also included are furnishing and installing appurtenant materials required for construction of the retaining wall as shown on the construction drawings.*

1.02 REFERENCE STANDARDS

A. *Segmental Retaining Wall Units*

1. ASTM C 1372

- Standard Specification for Segmental Retaining Wall Units

2. ASTM C 140

- Standard Test Methods of Sampling and Testing Concrete Masonry Units

B. *Geosynthetic Reinforcement*

1. ASTM D 4595

- Tensile Properties of Geotextiles by the Wide-Width Strip Method

2. ASTM D 5262

- Test Method for Evaluating the Unconfined Creep Behavior of Geosynthetics

3. GRI:GG1

- Single-Rib Geogrid Tensile Strength

4. GRI:GG5

- Geogrid Pullout

C. *Soils*

1. ASTM D 698

- Moisture Density Relationship for Soils, Standard Method

2. ASTM D 422

- Gradation of Soils

3. ASTM D 424

- Atterberg Limits of Soil

D. *Drainage Pipe*

1. ASTM D 3034

- Specification for Polyvinyl Chloride (PVC) Plastic Pipe

2. ASTM D 1248

- Specification for Corrugated Plastic Pipe

E. *Engineering Design*

1. "NCMA Design Manual for Segmental Retaining Walls," Second Edition

F. *Where specifications and reference documents*

conflict, the Architect/Engineer shall make the final determination of applicable document.

1.03 SUBMITTALS

A. Material Submittals: *The Contractor shall submit manufacturers' certifications two weeks prior to start of work stating that the SRW units and geosynthetic reinforcement meet the requirements of Section 2 of this specification.*

B. Design Submittal: *The Contractor shall submit two sets of detailed design calculations and final retaining wall plans for approval at least two weeks prior to the beginning of wall construction. All calculations and drawings shall be prepared and sealed by a professional Civil Engineer (P.E.) - (Wall Design Engineer) experienced in SRW design and licensed in the state where the wall is to be built.*

1.04 DELIVERY, STORAGE AND HANDLING

A. *Contractor shall check materials upon delivery to assure that specified type and grade of materials have been received and proper color and texture of SRW units have been received.*

B. *Contractor shall prevent excessive mud, wet concrete, epoxies and like materials that may affix themselves from coming in contact with materials.*

VERSA-LOK® Specifications

C. Contractor shall store and handle materials in accordance with manufacturer's recommendations.

D. Contractor shall protect materials from damage. Damaged materials shall not be incorporated into the retaining wall.

PART 2: MATERIALS

2.01 SEGMENTAL

RETAINING WALL UNITS

A. SRW units shall be machine-formed, Portland Cement concrete blocks specifically designed for retaining wall applications. SRW units currently approved for this project are: VERSA-LOK Standard Retaining Wall units as manufactured by _____.

B. Color of SRW units shall be _____.

C. Finish of SRW units shall be split-face.

D. SRW unit faces shall be of straight geometry.

E. SRW unit height shall be 6 inches.

F. SRW units (not including aggregate fill in unit voids) shall provide a minimum weight of 105 psf wall face area.

G. SRW units shall be solid through the full depth of the unit.

H. SRW units shall have a minimum depth (front face to rear) to height ratio of 2:1.

I. SRW units shall be interlocked with connection pins, designed with proper setback to provide 8:1 vertical to horizontal batter (a 7-degree cant from vertical).

J. SRW units shall be capable of being erected with the horizontal gap between adjacent units not exceeding 1/8 inch.

K. SRW units shall be capable of providing overlap of units on each successive course so that walls meeting at corner are interlocked and continuous. SRW units that require corners to be mitered shall not be allowed.

L. SRW units shall be capable of providing a split-face, textured surface for all vertical surfaces that will be exposed after completion of wall, including any exposed sides and backs of units.

M. SRW units shall be sound and free of cracks or other defects that would interfere with the proper placing of the unit or significantly impair the strength or permanence of the structure. Cracking or excessive chipping may be grounds for rejection. Units showing cracks longer than 1/2" shall not be used within the wall. Units showing chips visible at a distance of 30 feet from the wall shall not be used within the wall.

N. Concrete used to manufacture SRW units shall have a minimum 28 days compressive strength of 3,000 psi and a maximum moisture absorption rate, by weight, of 8 percent as determined in accordance with ASTM C140. Compressive strength test specimens shall conform to the saw-cut coupon provisions of ASTM C140.

O. SRW units' molded dimensions shall not differ more than $\pm 1/8$ inch from that specified, in accordance with ASTM C1372.

2.02 SEGMENTAL RETAINING

WALL UNIT CONNECTION PINS

A. SRW units shall be interlocked with VERSA-TUFF® Pins. The pins shall consist of glass-reinforced nylon made for the expressed use with the SRW units supplied.

VERSA-LOK® Specifications

2.03 GEOSYNTHETIC REINFORCEMENT

- A.** *Geosynthetic reinforcement shall consist of geogrids or geotextiles manufactured as a soil reinforcement element. The manufacturers/suppliers of the geosynthetic reinforcement shall have demonstrated construction of similar size and types of segmental retaining walls on previous projects. The geosynthetic type must be approved one week prior to bid opening. Geosynthetic types currently approved for this project are: VERSA-Grid® geogrids.*
- B.** *The type, strength and placement location of the reinforcing geosynthetic shall be as determined by the Wall Design Engineer, as shown on the final, P.E.-sealed retaining wall plans.*

2.04 LEVELING PAD

- A.** *Material for leveling pad shall consist of compacted sand, gravel or combination thereof (USCS soil types GP, GW, SP, & SW) and shall be a minimum of 6 inches in depth. Lean concrete with a strength of 200 to 300 psi and 3 inches thick maximum may also be used as a leveling pad material. The leveling pad should extend laterally at least a distance of 6 inches from the toe and heel of the lowermost SRW unit.*

2.05 DRAINAGE AGGREGATE

- A.** *Drainage aggregate shall be angular, clean stone or granular fill meeting the following gradation as determined in accordance with ASTM D422*

SIEVE SIZE	PERCENT PASSING
1 inch	100
3/4 inch	75-100
No. 4	0-60
No. 40	0-50
No. 200	0-5

2.06 DRAINAGE PIPE

- A.** *The drainage collection pipe shall be a perforated or slotted PVC, or corrugated HDPE pipe. The drainage pipe may be wrapped with a geotextile to function as a filter.*
- B.** *Drainage pipe shall be manufactured in accordance with ASTM D 3034 and/or ASTM D 1248*

2.07 REINFORCED (INFILL) SOIL

- A.** *The reinforced soil material shall be free of debris. Unless otherwise noted on the final, P.E. sealed retaining wall plans prepared by the Wall Design Engineer, the reinforced material shall consist of the inorganic USCS soil types GP, GW, SW, SP, SM meeting the following gradation, as determined in accordance with ASTM D422:*

SIEVE SIZE	PERCENT PASSING
1 inch	100
No. 4	20-100
No. 40	0-60
No. 200	0-35

- B.** *The maximum particle size of poorly-graded gravels (GP) (no fines) should not exceed 3/4 inch unless expressly approved by the Wall Design Engineer and the long-term design strength (LTDS) of the geosynthetic is reduced to account for additional installation damage from particles larger than this maximum.*
- C.** *The plasticity of the fine fraction shall be less than 20.*

VERSA-LOK® Specifications

PART 3: DESIGN PARAMETERS

3.01 SOIL

A. The following soil parameters, as determined by the Owner's Geotechnical Engineer, shall be used for the preparation of the final design:

	Unit Weight (γ) (pcf)	Internal Friction Angle (ϕ) (degrees)	Cohesion (c)
Reinforced Fill: _____	_____	_____	0
Retained Soil: _____	_____	_____	0
Foundation Soil: _____	_____	_____	_____

(If internal friction angles are not available for the above section, the specifier can provide the USCS soil type classification for the reinforced, retained and foundation soils and/or attach the geotechnical investigation report for this project.)

B. Should the actual soil conditions observed during construction differ from those assumed for the design, design shall be reviewed by the Wall Design Engineer at the Owner's Geotechnical Engineer's direction.

3.02 DESIGN

A. The design analysis for the final, P.E.-sealed retaining wall plans prepared by the Wall Design Engineer shall consider the external stability against sliding and overturning, internal stability, and facial stability of the reinforced soil mass and shall be in accordance with acceptable engineering practice and these specifications. The internal and external stability analysis shall be performed in accordance with the "NCMA Design Manual for Segmental Retaining Walls," using the recommended minimum factors of safety in this manual.

B. External stability analysis for bearing capacity, global stability and total and differential settlement shall be the responsibility of the Owner and the Owner's Geotechnical Engineer. Geotechnical Engineer shall perform bearing capacity, settlement estimates and global stability analysis based on the final wall design provided by the Wall Design Engineer and coordinate any required changes with Wall Design Engineer.

C. While vertical spacing between geogrid layers may vary, it shall not exceed 2 feet maximum in the wall design.

D. The geosynthetic placement in the wall design shall have 100 percent continuous coverage parallel to the wall face. Gapping between horizontally adjacent layers of geosynthetic (partial coverage) will not be allowed.

PART 4: CONSTRUCTION

4.01 INSPECTION

A. The Owner or Owner's Representative is responsible for verifying that the contractor meets all the requirements of the specification. This includes all submittals for materials and design, qualifications and proper installation of wall system.

B. Contractor's field construction supervisor shall have demonstrated experience and be qualified to direct all work at the site.

4.02 EXCAVATION

A. Contractor shall excavate to the lines and grades shown on the project grading plans. Contractor shall take precautions to minimize over-excavation. Over-excavation shall be filled with compacted infill material, or as directed by the Engineer/Architect, at the Contractor's expense.

VERSA-LOK® Specifications

B. Contractor shall verify location of existing structures and utilities prior to excavation. Contractor shall ensure all surrounding structures are protected from the effects of wall excavation. Excavation support, if required, is the responsibility of the Contractor.

4.03 FOUNDATION PREPARATION

A. Following the excavation, the foundation soil shall be examined by the Owner's Engineer to assure actual foundation soil strength meets or exceeds the assumed design bearing strength. Soils not meeting the required strength shall be removed and replaced with infill soils, as directed by the Owner's Engineer.

B. Foundation soil shall be proofrolled and compacted to 95 percent standard Proctor density and inspected by the Owner's Engineer prior to placement of leveling pad materials.

4.04 LEVELING PAD CONSTRUCTION

A. Leveling pad shall be placed as shown on the final, P.E.-sealed retaining wall plans with a minimum thickness of 6 inches. The leveling pad should extend laterally at least a distance of 6 inches from the toe and heel of the lowest SRW unit.

B. Granular leveling pad material shall be compacted to provide a firm, level bearing surface on which to place the first course of units. Well-graded sand can be used to smooth the top 1/4- to 1/2-inch of the leveling pad. Compaction will be with mechanical plate compactors to achieve 95 percent of maximum standard Proctor density (ASTM D 698).

4.05 SRW UNIT INSTALLATION

A. All SRW units shall be installed at the proper elevation and orientation as shown on the final, P.E.-sealed retaining wall plans and details as directed by the Wall Design Engineer. The SRW units shall be installed in general accordance with the manufacturer's recommendations. The specifications and drawings shall govern in any conflict between the two requirements.

B. First course of SRW units shall be placed on the leveling pad. The units shall be leveled side-to-side, front-to-rear and with adjacent units, and aligned to ensure intimate contact with the leveling pad. The first course is the most important to ensure accurate and acceptable results. No gaps shall be left between the front of adjacent units. Alignment may be done by means of a string-line or offset from baseline to the back of the units.

C. All excess debris shall be cleaned from top of units and the next course of units installed on top of the units below.

D. Two VERSA-TUFF Pins shall be inserted through the pin holes of each upper course unit into receiving slots in lower-course units. Pins shall be fully seated in the pin slot below. Units shall be pushed forward to remove any looseness in the unit-to-unit connection.

E. Prior to placement of next course, the level and alignment of the units shall be checked and corrected where needed.

F. Layout of curves and corners shall be installed in accordance with the wall plan details or in general accordance with SRW manufacturer's installation guidelines. Walls meeting at corners shall be interlocked by overlapping successive courses.

G. Procedures C. through F. shall be repeated until reaching top of wall, just below the height of the cap units. Geosynthetic reinforcement, drainage materials and reinforced backfill shall be placed in sequence with unit installation as described in Section 4.06, 4.07 and 4.08.

VERSA-LOK® Specifications

4.06 GEOSYNTHETIC

REINFORCEMENT PLACEMENT

- A.** All geosynthetic reinforcement shall be installed at the proper elevation and orientation as shown on the final, P.E.-sealed retaining wall plan profiles and details, or as directed by the Wall Design Engineer.
- B.** At the elevations shown on the final plans, (after the units, drainage material and backfill have been placed to this elevation) the geosynthetic reinforcement shall be laid horizontally on compacted infill and on top of the concrete SRW units. It shall be placed to within 1 inch of the front face of the unit below. Embedment of the geosynthetic in the SRW units shall be consistent with SRW manufacturer's recommendations. Correct orientation of the geosynthetic reinforcement shall be verified by the Contractor to be in accordance with the geosynthetic manufacturer's recommendations. The highest strength direction of the geosynthetic must be perpendicular to the wall face.
- C.** Geosynthetic reinforcement layers shall be one continuous piece for their entire embedment length. Splicing of the geosynthetic in the design strength direction (perpendicular to the wall face) shall not be permitted. Along the length of the wall (parallel to the face), horizontally adjacent sections of geosynthetic reinforcement shall be butted in a manner to assure 100 percent coverage parallel to the wall face.
- D.** Tracked construction equipment shall not be operated directly on the geosynthetic reinforcement. A minimum of 6 inches of backfill is required prior to operation of tracked vehicles over the geosynthetic. Turning should be kept to a minimum. Rubber-tired equipment may pass over the geosynthetic reinforcement at slow speeds (less than five miles per hour).
- E.** The geosynthetic reinforcement shall be free of wrinkles prior to placement of soil fill. The nominal tension shall be applied to the reinforcement and secured in place with staples, stakes or by hand tensioning until reinforcement is covered by 6 inches of fill.

4.07 DRAINAGE MATERIALS

- A.** Drainage aggregate shall be installed to the line, grades and sections shown on the final P.E.-sealed retaining wall plans. Drainage aggregate shall be placed to the minimum thickness shown on the construction plans between and behind units (a minimum of 1 cubic foot for each exposed square foot of wall face unless otherwise noted on the final wall plans).
- B.** Drainage collection pipes shall be installed to maintain gravity flow of water to outside the reinforced soil zone. The drainage collection pipe shall daylight into a storm sewer manhole or along a slope at an elevation lower than the lowest point of the pipe within the aggregate drain.

4.08 BACKFILL PLACEMENT

- A.** The reinforced backfill shall be placed as shown in the final wall plans in the maximum compacted lift thickness of 10 inches and shall be compacted to a minimum of 95 percent of standard Proctor density (ASTM D 698) at a moisture content within 2 percent of optimum. The backfill shall be placed and spread in such a manner as to eliminate wrinkles or movement of the geosynthetic reinforcement and the SRW units.
- B.** Only hand-operated compaction equipment shall be allowed within 3 feet of the back of the wall unit. Compaction within the 3 feet behind the wall unit shall be achieved by at least three (3) passes of a lightweight mechanical tamper, plate or roller.
- C.** At the end of each day's operation, the Contractor shall slope the last level of backfill away from the wall facing and reinforced backfill to direct water runoff away from the wall face.
- D.** At completion of wall construction, backfill shall be placed level with final top of wall elevation. If final grading, paving, landscaping and/or storm drainage installation adjacent to the wall is not placed immediately after wall completion, temporary grading and drainage shall be provided to ensure water runoff is not directed at the wall nor allowed to collect or pond behind the wall until final construction adjacent to the wall is completed.

VERSA-LOK® Specifications

4.09 SRW CAPS

- A. SRW caps shall be properly aligned and glued to underlying units with VERSA-LOK Concrete Adhesive, a flexible, high-strength adhesive. Rigid adhesive or mortar are not acceptable.*

- B. Caps shall overhang the top course of units by 3/4 inch to 1 inch. Slight variation in overhang is allowed to correct alignment at the top of the wall.*

4.10 CONSTRUCTION ADJACENT TO COMPLETED WALL

- A. The Owner or Owner's Representative is responsible for ensuring that construction by others adjacent to the wall does not disturb the wall or place temporary construction loads on the wall that exceed design loads, including loads such as water pressure, temporary grades or equipment loading. Heavy paving or grading equipment shall be kept a minimum of 3 feet behind the back of the wall face. Equipment with wheel loads in excess of 150 psf live load shall not be operated within 10 feet of the face of the retaining wall during construction adjacent to the wall. Care should be taken by the General Contractor to ensure water runoff is directed away from the wall structure until final grading and surface drainage collection systems are completed.*

VERSA-LOK® Construction Details

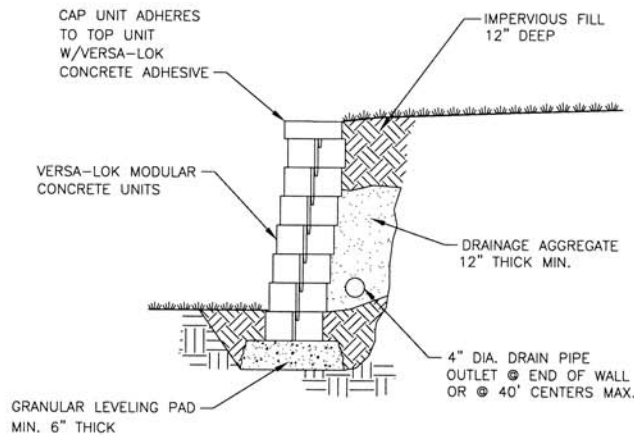

TYPICAL SECTION—UNREINFORCED RETAINING WALL

SCALE: NONE

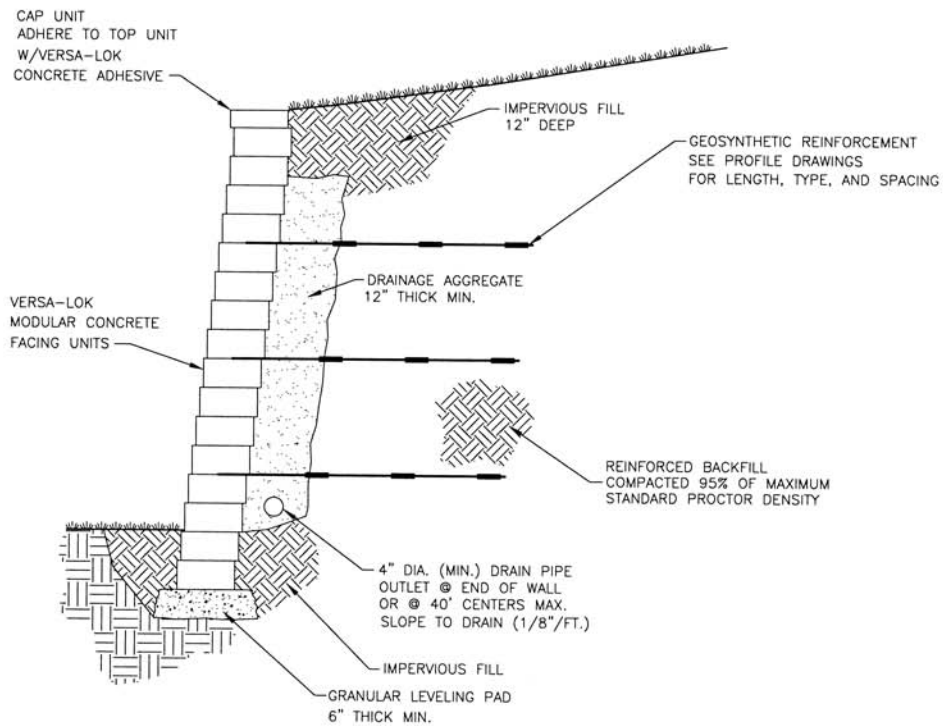

TYPICAL SECTION—REINFORCED RETAINING WALL

MODULAR CONCRETE UNIT
SCALE: NONE

VERSA-LOK® Construction Details

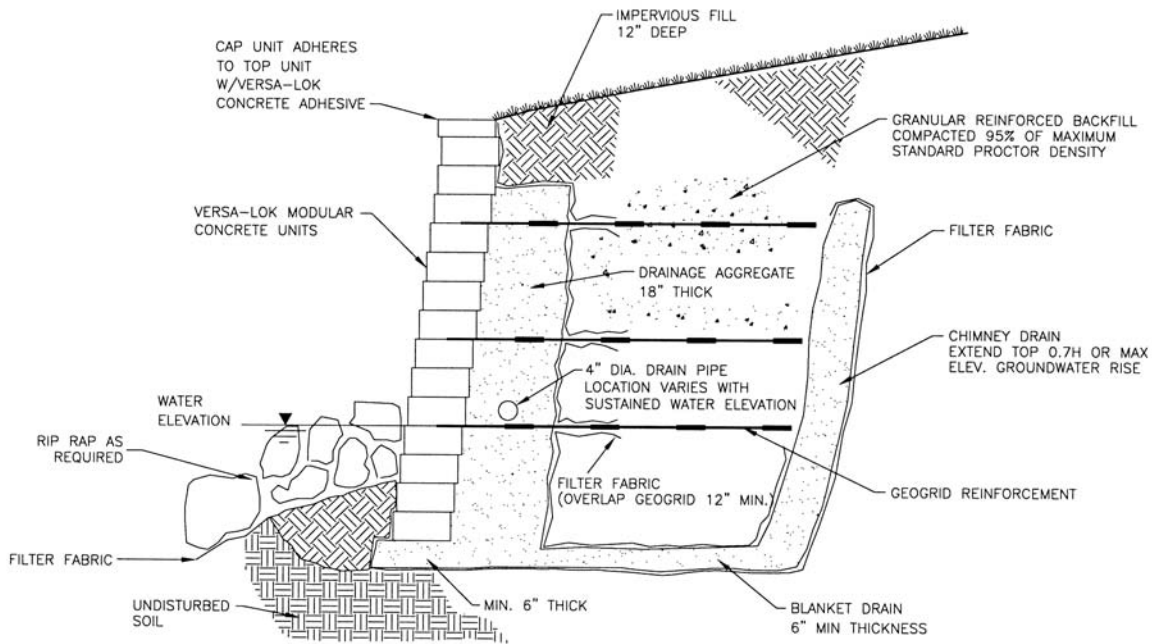

TYPICAL SECTION—REINFORCED SHORELINE WALL

WITH BLANKET AND CHIMNEY DRAIN

SCALE: NONE

VERSA-LOK® Construction Details

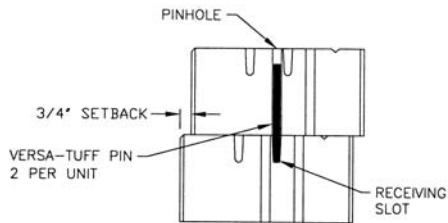

PINNING DETAIL

CROSS SECTION
SCALE: NONE

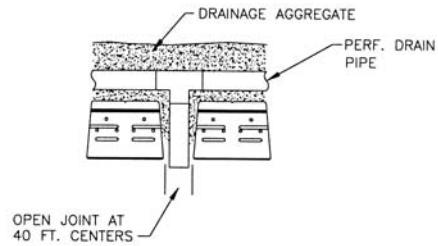

DRAIN DETAIL

WALLS OVER 4'
SCALE: NONE

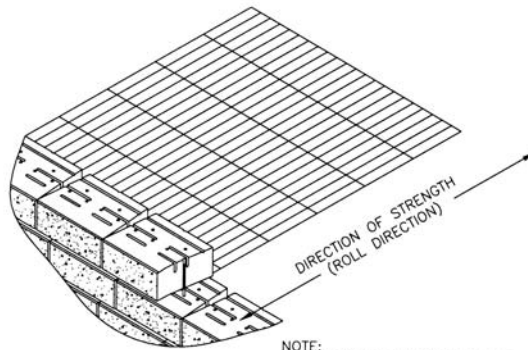

- NOTE:
1. FOLLOW GEOSYNTHETIC GRID MANUFACTURER'S
INSTALLATION INSTRUCTIONS AND SPECIFICATIONS
2. GEOGRID LENGTH AND ELEVATION PLACEMENT
SHALL BE DETERMINED BY PROJECT ENGINEER

GEOSYNTHETIC INSTALLATION DETAIL

SCALE: NONE

VERSA-LOK® Construction Details

STAIR DETAIL
 BASE PEDESTAL METHOD
 SCALE: NONE

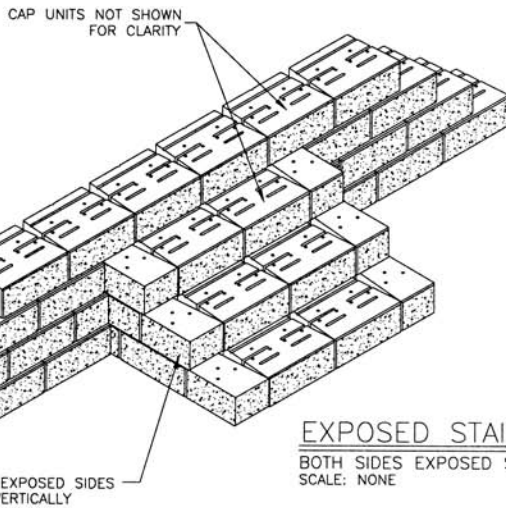
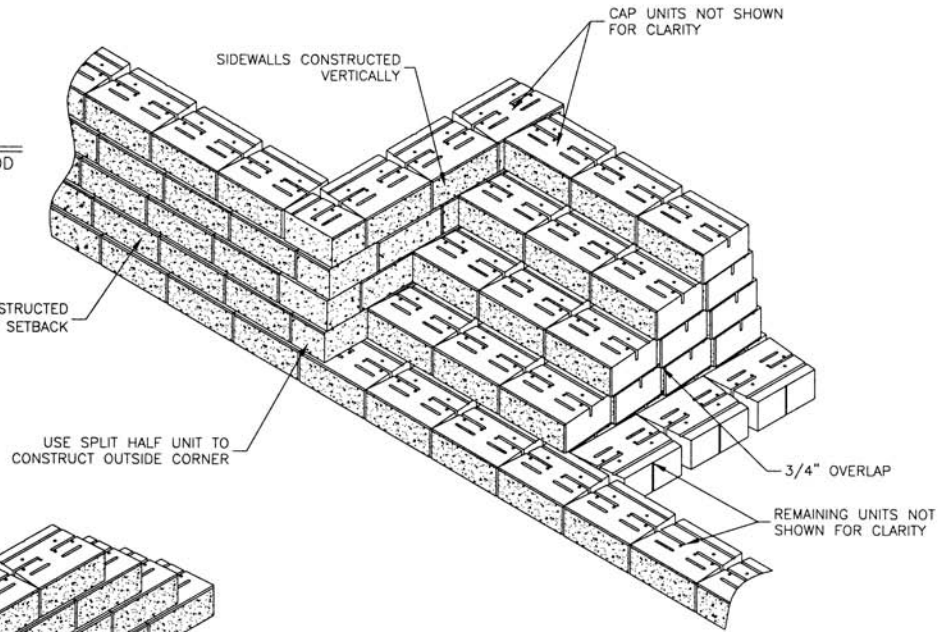

EXPOSED STAIRS DETAIL
 BOTH SIDES EXPOSED STAIRS
 SCALE: NONE

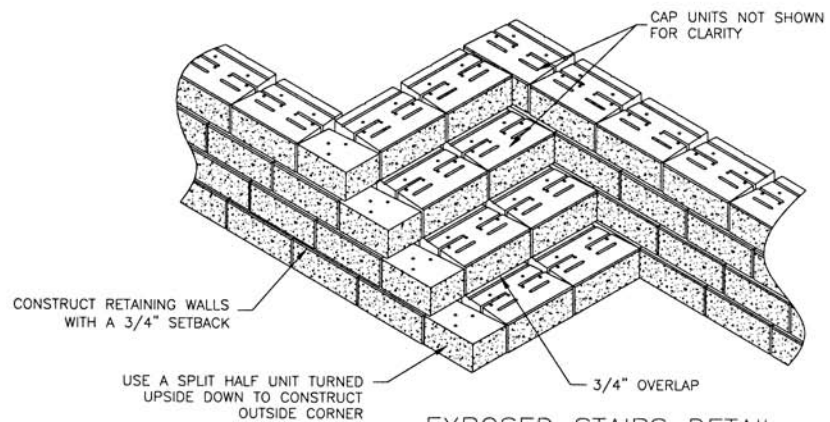

EXPOSED STAIRS DETAIL
 ONE SIDE EXPOSED STAIRS
 SCALE: NONE

VERSA-LOK® Construction Details

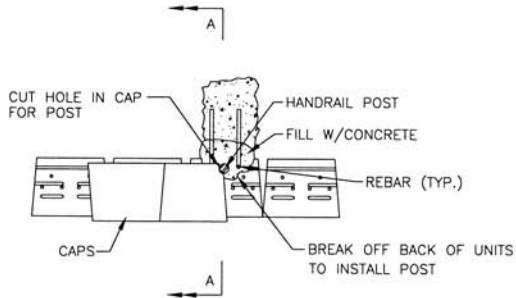

POST DETAIL - PLAN VIEW
TYPICAL HANDRAIL AND/OR FENCE POST
SCALE: NONE

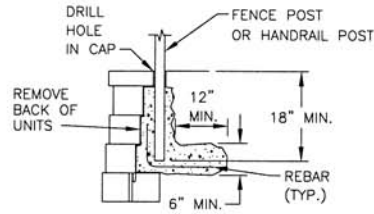

POST DETAIL - SECTION A-A
TYPICAL HANDRAIL AND/OR FENCE POST
SCALE: NONE

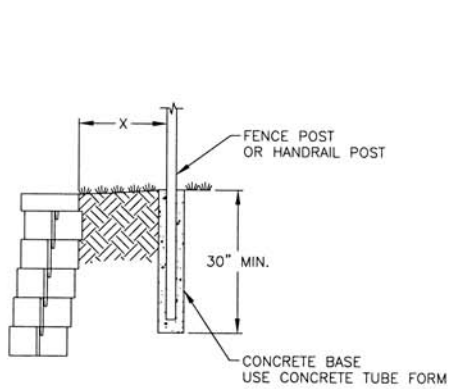

POST DETAIL
TYPICAL HANDRAIL AND/OR FENCE POST
SCALE: NONE

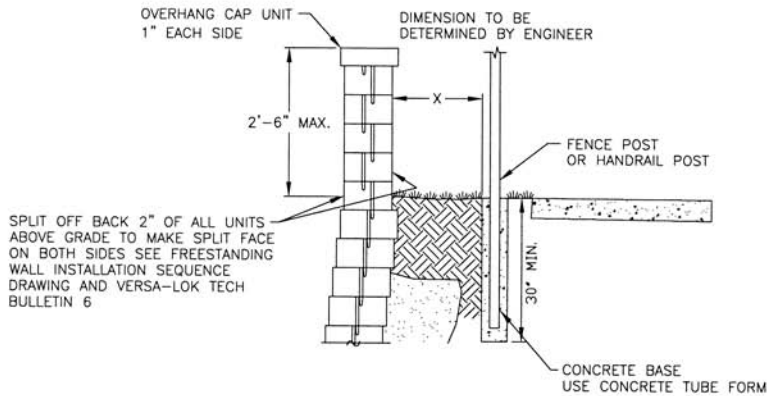

FREESTANDING WALL DETAIL (STRAIGHT WALLS ONLY)
TYPICAL HANDRAIL AND/OR FENCE POST
SCALE: 1/2"=1'

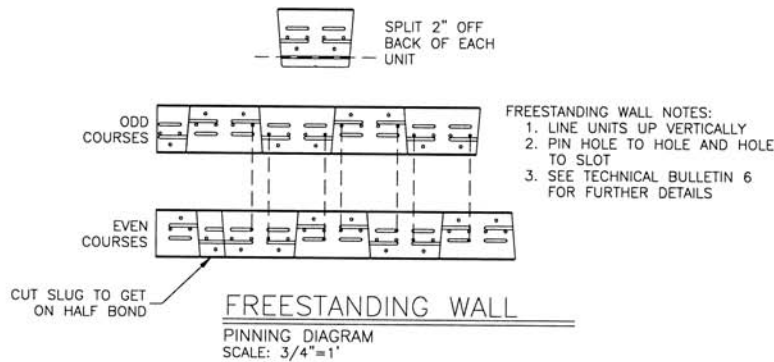

FREESTANDING WALL
PINNING DIAGRAM
SCALE: 3/4"=1'

VERSA-LOK® Construction Details

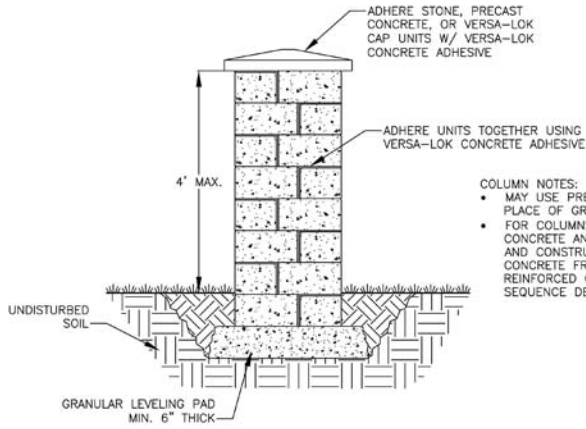

- COLUMN NOTES:**
- MAY USE PRECAST CONCRETE PAD IN PLACE OF GRANULAR LEVELING PAD
 - FOR COLUMNS TALLER THAN 4' PLACE CONCRETE AND REBAR WITHIN THE COLUMN, AND CONSTRUCT ON A REINFORCED CONCRETE FROST FOOTING. SEE REINFORCED COLUMN INSTALLATION SEQUENCE DETAIL

20" STANDARD COLUMN SECTION
STANDARD-UNREINFORCED COLUMN (4' TALL MAX.)
SCALE: NONE

ODD COURSE

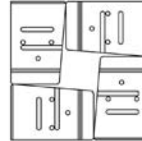

EVEN COURSE

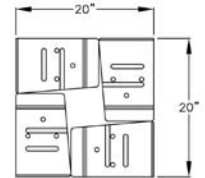

INSTALLATION SEQUENCE
UNREINFORCED COLUMN (4' TALL MAX.)
SCALE: NONE

- COLUMN NOTES:**
- UNITS WILL NOT PIN
 - ADHERE UNITS TOGETHER USING VERSA-LOK CONCRETE ADHESIVE

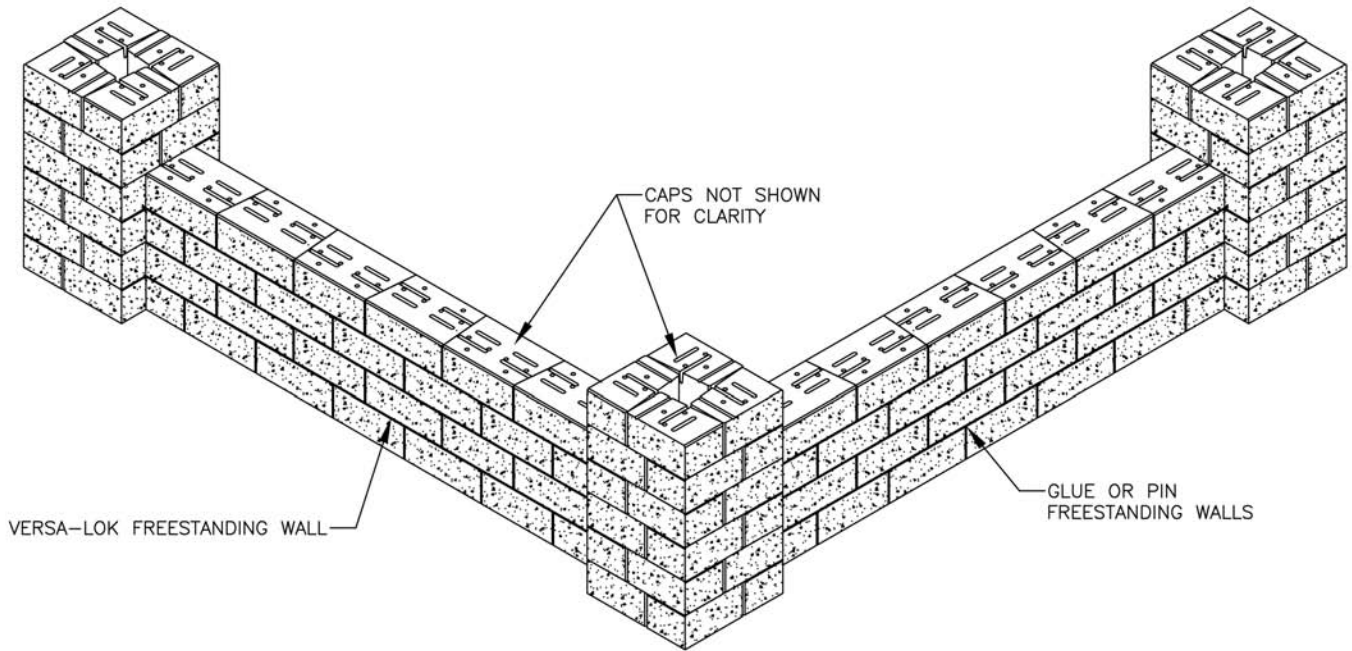

COLUMNS WITH FREESTANDING WALLS
COLUMNS
SCALE: NONE

VERSA-LOK® Construction Details

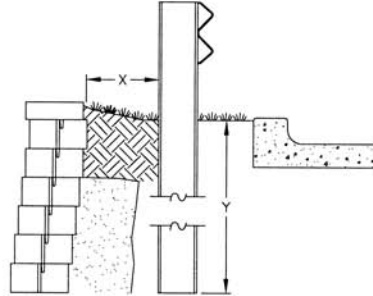

GUARD RAIL DETAIL

TYPICAL GUARD RAIL
SCALE: NONE

GUARD RAIL NOTES:

1. DISTANCE X AND Y TO BE DETERMINED BY ENGINEER BASED ON SOIL AND LOADING CONDITIONS.
2. INSTALL H-PILE OR WOOD POST AS PER MANUFACTURER'S RECOMMENDATIONS.
3. AUGERING OR DRIVING OF POST MAY PIERCE UPPER LAYER OF GEOSYNTHETIC AS PER ENGINEER'S DESIGN.

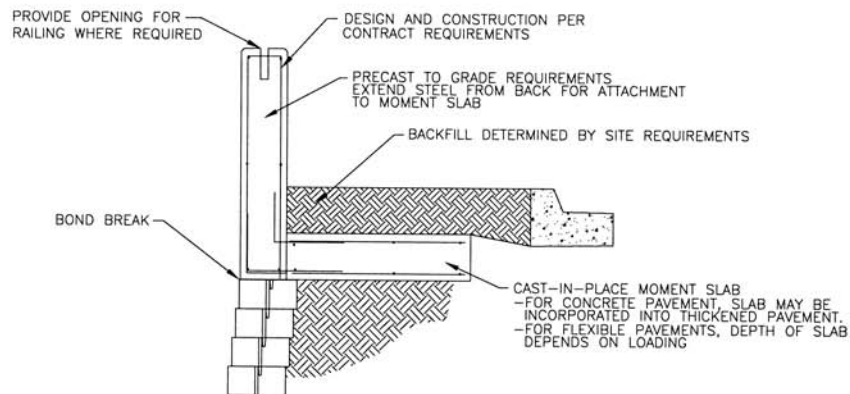

COPING DETAIL

TRAFFIC BARRIER SECTION
SCALE: NONE

BARRIER NOTES:

1. BARRIERS MAY BE SET ON TOP OF OR BEHIND WALL.
2. BARRIERS ON TOP OF WALL SHALL BE DESIGNED TO ACCOMMODATE DIFFERENTIAL MOVEMENT OF RETAINING WALL.
3. STEEL DESIGN AND COPING GEOMETRY WILL VARY WITH SITE LOADINGS. DESIGN MUST BE PROJECT SPECIFIC.
4. DURING PLACEMENT OF CONCRETE, PRECAUTIONS SHOULD BE TAKEN TO REDUCE LATERAL PRESSURES ON THE VERSA-LOK WALL. FORMING AND/OR TEMPORARY BRACING MAY BE REQUIRED.



Standard Design & Installation Guidelines

Made worldwide under license from VERSA-LOK Retaining Wall Systems.

Products shown may be covered by one or more of the following:

U.S. Patent D319,885, U.S. Patent D321,060, U.S. Patent D341,215, U.S. Patent D346,667, U.S. Patent D378,702, U.S. Patent D391,376, U.S. Patent D430,680, U.S. Patent D435,302, U.S. Patent D439,678, U.S. Patent D452,332, U.S. Patent D458,387, U.S. Patent 6,488,448, U.S. Patent 6,960,048, U.S. Patent 7,229,235, U.S. Patent 7,244,079, U.S. Patent D552,258, U.S. Patent D555,810 and other U.S. patents pending; Canadian Industrial Design Registration No. 63929, No. 71472, No. 73910, No. 73911, No. 73912, No. 77816, No. 79058, No. 82288, and No. 89084. I.C.B.O. No. 4625, Canadian Patent 2,313,061

THE INFORMATION, INCLUDING TECHNICAL AND ENGINEERING DATA, FIGURES, TABLES, DESIGNS, DRAWINGS, DETAILS, SUGGESTED PROCEDURES AND SUGGESTED SPECIFICATIONS, PRESENTED IN THIS PUBLICATION IS FOR GENERAL INFORMATION ONLY. WHILE EVERY EFFORT HAS BEEN MADE TO ENSURE ITS ACCURACY, THIS INFORMATION SHOULD NOT BE USED OR RELIED UPON FOR ANY APPLICATION WITHOUT VERIFICATION OF ACCURACY, SUITABILITY, AND APPLICABILITY FOR THE USE CONTEMPLATED, WHICH IS THE SOLE RESPONSIBILITY OF THE USER. A FINAL, PROJECT-SPECIFIC DESIGN SHOULD BE PREPARED BY A QUALIFIED, LICENSED, PROFESSIONAL ENGINEER BASED ON ACTUAL SITE CONDITIONS. VERSA-LOK RETAINING WALL SYSTEMS DISCLAIMS ANY AND ALL EXPRESS OR IMPLIED WARRANTIES OF MERCHANTABILITY FITNESS FOR ANY GENERAL OR PARTICULAR PURPOSE, TRADEMARK OR COPYRIGHT IN REGARD TO INFORMATION OR PRODUCTS CONTAINED OR REFERRED TO HEREIN.

6348 Hwy. 36 Blvd., Suite 1, Oakdale, MN 55128
(800) 770-4525 (651) 770-3166 office (651) 770-4089 fax www.versa-lok.com